

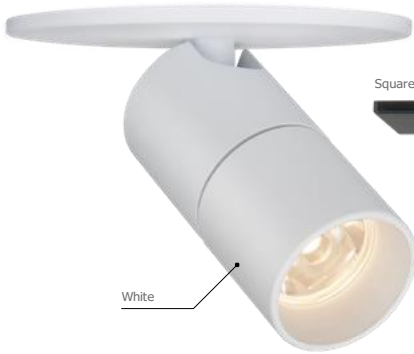

PRODUCT FEATURES

- To be used with constant voltage DC 24V driver
- Mini spotlight with various beam angle
- Dimmable with available accessories
- Available in black and white

Round Plate



White

Square Plate



Black

PRODUCT SPECIFICATIONS

- Voltage : DC 24V
- Operating Temperature : 32-113° F (0-45° C)
- Lamp Life : 50,000hr / 70%
- Available CCTs : 2700K, 3000K, 3500K, 4000K
- Color Rendering Index : CRI>90
- Finishes : Black, White
- Dimming : 0-10V
- 5 year warranty

SPECIFICATION

Model Name	Power Input	Lamp Power	Luminous Flux	Luminous Efficacy	Color Rendering Index	Color Temperature	Beam Angle	Plate	Operating Temperature
DVP340K-24V-BK-28-RP	DC 24V	2.6 W	253.1 lm	97.7 lm/W	CRI > 90	2700K 3000K 3500K 4000K	28° 40° 50°	Round Square	32-113F

DIMENSION

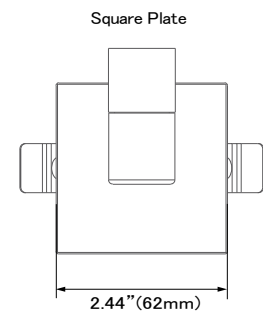
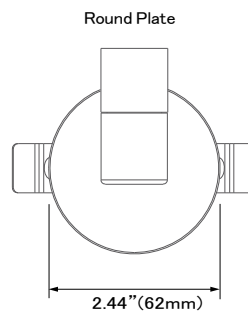
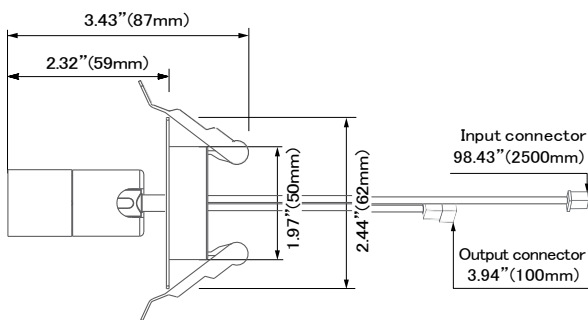

INSTALLATION

Hole Diameter

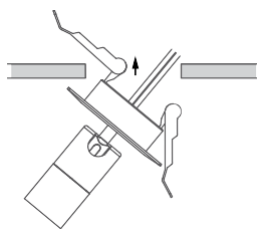
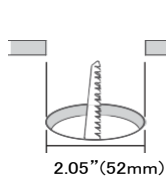

Mounting spring installation

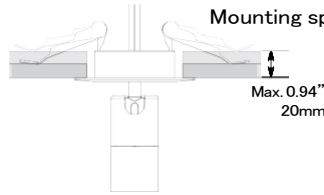

★ Linkabel between FLX Spot DVP and FLX Spot DVP (Max. 10 units connectable)

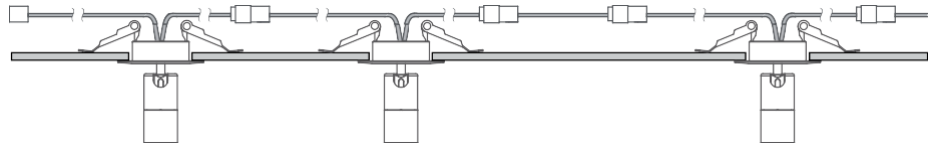

BEAM ANGEL

DVP3 40K-24V-BK-28-RP

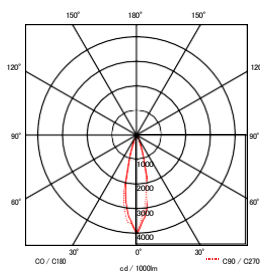

DVP3 40K-24V-BK-40-RP

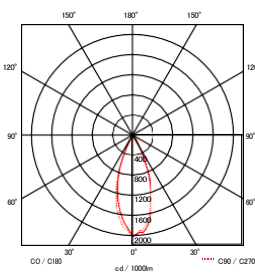

DVP3 40K-24V-BK-50-RP

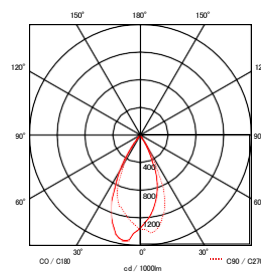

COMPONENTS



FLX Spot DVP
__DVP340K-24V-BK-28-RP



FLX Spot DVP
__DVP340K-24V-BK-28-SP



DVP-HOOD
__DVP3-HOOD-BK-28
Hood with lens for replacement



12 Port Hub
__D12P-HUB
Included with Cord and Plug drivers. Order separately for Hard Wire or 3rd Party Drivers



LED Drivers
__FLC30-24V/XL
__FLC75-24V/XL
with distributor and power cord (70" (1800mm))



Hard Wire Driver
__XLD200-224V-FCL-DIM
__XLD75-124V-FC
(90V to 300V)



Hard Wire Driver
__FLE90-24V-L10-DIM
Additional Power Supply/Driver Options Available. Please consult Factory.



Occupancy sensor
__FLS-P24V



Dimming Interface
__FDC-L10
Max. 100W(100W/CH, 1CH)
0-10V Signal



Dimming Interface -
__FDA-L2MO
Max. 200W(100W/CH, 2CH)
__FDA-L5M
Max. 200W(50W/CH, 5CH)



Dimming Interface (Dail)
__FDD-L1DA



Door and motion sensor
__FLS-M24V

SPECIFICATION GUIDE

MODEL	COLOR	FINISH	BEAM ANGLE	TYPE
DVP 3	27K -2700K 30K -3000K 35K -3500K 40K -4000K	BK - Black WT - White SV - Silver (Special Order Option) GD - Gold (Special Order Option)	28° 40° 50°	RP - Round Plate SP - Square Plate