

# Byron™

## Additional Bell Push

BY30  
BY33

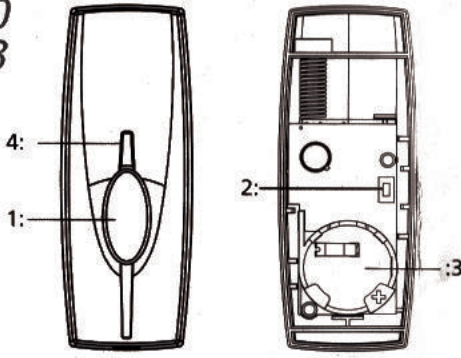

- 1: Push Button
- 2: Melody Selector - inside Bell Push
- 3: Bell Push Battery - inside Bell Push
- 4: Signal Sent LED

### Setup:

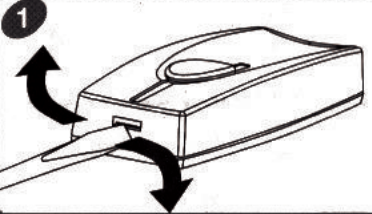

- 1: Place a small flat screwdriver into the locking clip on the base of the Bell Push
- 2: Gently twist
- 3: The backing plate will unclip

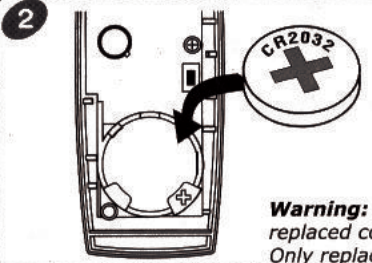

- 1: Insert CR2032 battery (Supplied) into the battery holder.
- 2: Make sure the positive side is facing upwards.
- 3: Replace back plate.

**Warning:** Make sure that the batteries are replaced correctly to avoid battery failure. Only replace with same or equivalent type.



**Avoid** locating the Bell Push/Chime on or directly near metallic surfaces as this may reduce the operation range.  
**UPVC Door Frames:** When locating the bell push onto a UPVC door, always check the operating performance before final installation, internal metal frame may affect performance.

*Note: Try adjusting the location of the Bell Push to the Left/Right or place on external wall.*

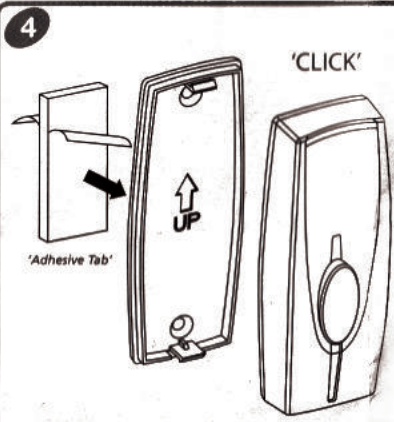

- 1: Using back plate as a template
- 2: Make sure UP arrows point UP.
- 3: Select ideal position for best performance.
- 4: Stick adhesive tab back plate & stick into position.
- 5: Clip the Bell Push on to the back plate making sure the Bell Push 'CLICKS' in to place.

*NOTE: Bell Push can be screwed into position using the two hole marks as guides on the back plate. Screws not supplied.*

## Chime With Volume Control

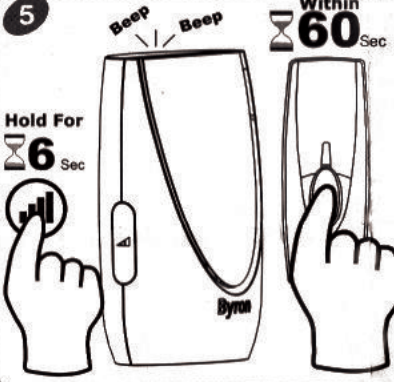

- 1: Press and hold the 'VOL' button on the Door Chime, until the Chime goes 'Beep Beep' (6 Seconds)
  - 2: Press the Bell Push within 60 seconds to learn the Bell Push to the chime.
  - 3: The Chime will ring to confirm setup.
- Note: Maximum of 6 Bell Pushes can be learnt to a single Chime.*

## Chime Without Volume Control

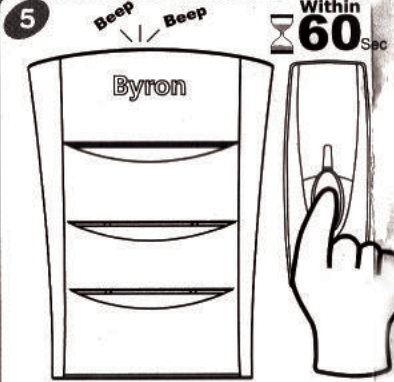

- Plug-in Chime: Remove from socket and then plug chime back-in
  - Portable Chimes: Remove the batteries and then reinsert the batteries
  - 1: The Chime will 'Beep Beep'.
  - 2: Press the Bell Push within 60 seconds to learn the Bell Push to the chime.
  - 3: The Chime will ring to confirm setup.
- Note: Maximum of 2 Bell Pushes can be learnt to a single Chime for Front/Back Door use.*

## Changing Batteries:

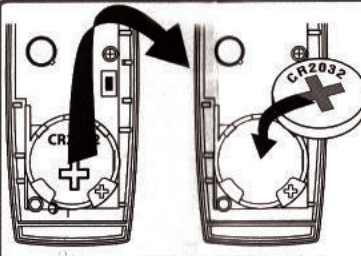

- Bell Push:
  - 1: Remove back plate from the Bell Push.
  - 2: Remove old battery from the holder.
  - 3: Replace with new 'CR2032' 3V battery.
  - 4: Insert into holder making sure '+' is facing up.
  - 5: Test Chime Kit.

**1 x 3V CR2032**

Type R2 Device - device where the sound output is created by the initial operation of the control and where the period of sound output continues for the designed duration irrespective of condition of the control.

### IMPORTANT:

There are no serviceable parts, do not repair. The appliance is not to be used by children or persons with reduced physical, sensory or mental capabilities, or lack of experience and knowledge, unless they have been given supervision or instruction. Children should be supervised to ensure that they do not play with the appliance.



Specification  
Bell Push: BY30, BY33  
Power: 1 x CR2032 3V DC Battery (Included)  
IP44 Weather Resistant



Tel: 0845 2301231 (UK)  
10-4 Mon-Fri, Local call charges apply

<http://www.chbyron.eu/support>

[www.chbyron.eu/support](http://www.chbyron.eu/support)



Smartwares Safety & Lighting  
34, Sherwood Rd,  
Aston Fields,  
Bromsgrove,  
B60 3DR  
UK

smartwares		433MHz	
SAFETY & LIGHTING		CE	
RATTE APPROVED			
A	A	IRL	A
B	A	I	A
DK	A	L	A
FIN	A	NL	A
F	A	D	A
GR	A	S	A
LY	A	S	A
UK	A	M	A
BG	A	N	A
CZ	A	SK	A
EST	A	SLO	A
H	A	CH	A
N	A	PL	A
LV	A	RO	A

