

Square Instruction Manual

Warning:

This Lighting fixture must be installed under instruction of this manual. Before installation, please check the product model according to the detailed specification sheet attached below.

Note:

This fixture must be fixed by a competent and qualified electrician in accordance with wiring regulations and current building regulations; This manual is subject to change without prior notice.

Specification sheet

Art.-no.	Product dimension	LED qty	Angle	Operating voltage	Rated wattage	Safety class	Safety type
LEDPROJECTRGBV2	L:343×W450×D95	48LEDS	33°	24V DC	70W	III	IP65

Installation Steps

1. Switch off the main power before installation.

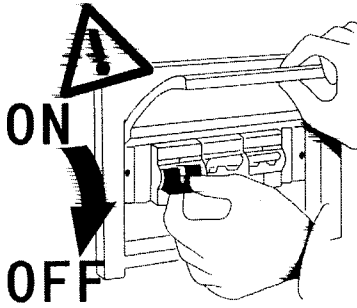

2. Choose proper installation way

Vertical installation

The product can be directly installed on the wall and ground.

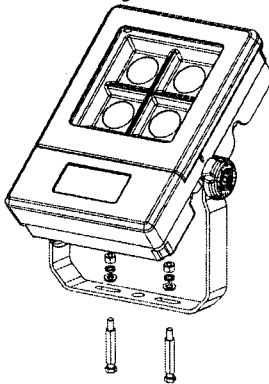

3. Add an installation pole according to the project requirements.

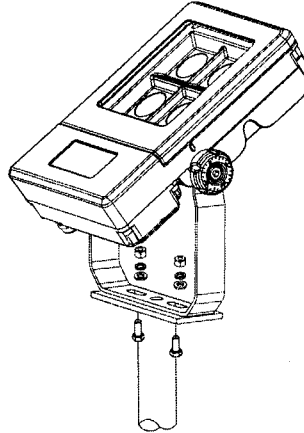

Fasten the bracket screws. It can bear the force 3 times its weight, which promises the fixture locked tightly.

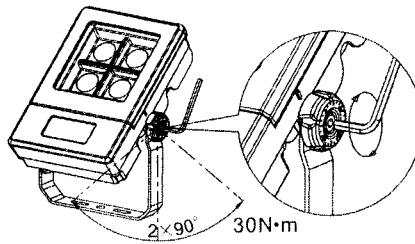

Warning:

This fixture can be installed in other ways, but it can not be covered on its heatsink, which will influence the function.

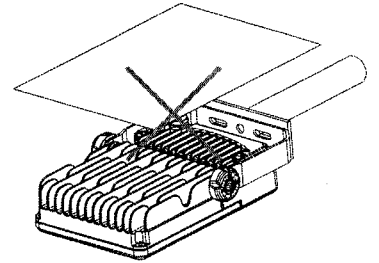

Do not open the front protection cover, or make modification in any way.

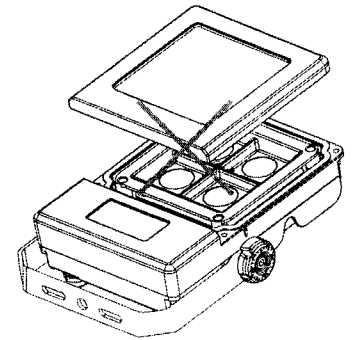

Installation holes dimension

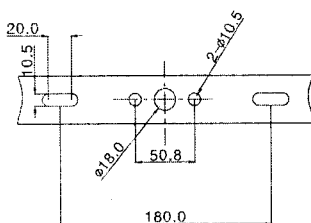

3. Make sure the gland tightly fastened, and the screws of power supply back cover screwed properly, tightly and evenly.

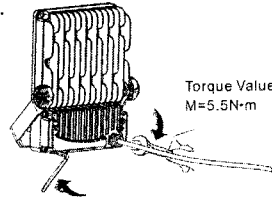

Notes:

1. Connect the Male to Female plugs properly, have good contact. (picture 1)
2. Fasten the protection cap, prevent water entering. (picture 2)
3. Make protection on the last fixture in the system, fasten the protection cap or other device. (picture 3)

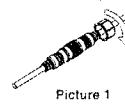

Picture 1

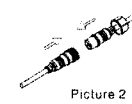

Picture 2

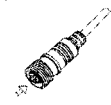

Picture 3

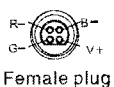
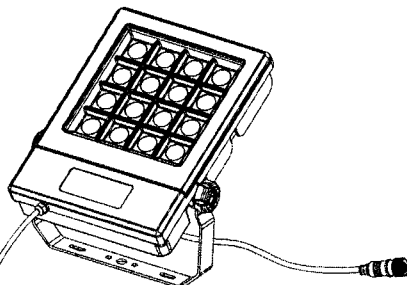

Female plug

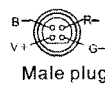

Male plug

Fixture Wiring diagram:

1. Can be used as single product; more products together, maximum at 2 pcs;
2. Distance between the fixtures no longer than 10 meters;
3. Male plug on the last fixture will be protected with waterproof cap.