

LCP5

LUTRON CONTROL PANEL - 5 RAIL

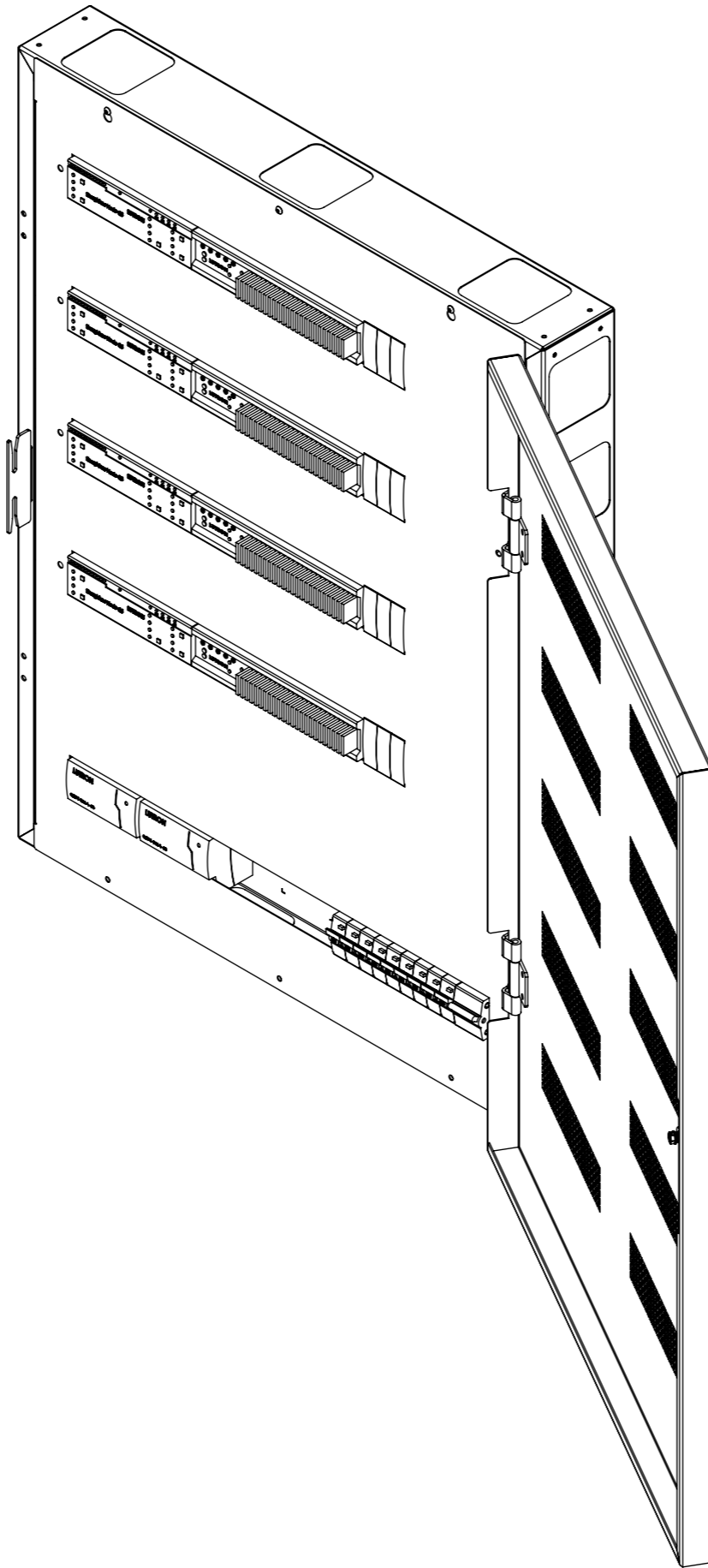

future automation



LCP5

LUTRON CONTROL PANEL - 5 RAIL



SPECIFICATION	MEASUREMENTS
Product Dimensions	900mm (35.4") x 690mm (27.2") x 141.5mm (5.6")
Number of DIN Rails	5
Finish (Custom Available)	Lid - Black Textured Paint, Box - Zintec Coated Steel
Maximum Number of Lutron Modules	8
Depth From Wall	141.5mm (5.6")
Wall Mount Type	80mm (3.1") Keyhole Slots
Shipping Dimensions	1010mm (39.8") x 840mm (33.0") x 240 (9.5")
Shipping Weight	24.5Kg (54lbs)

LCP5

LUTRON CONTROL PANEL - 5 RAIL



future automation

ENCLOSURE DIMENSIONS

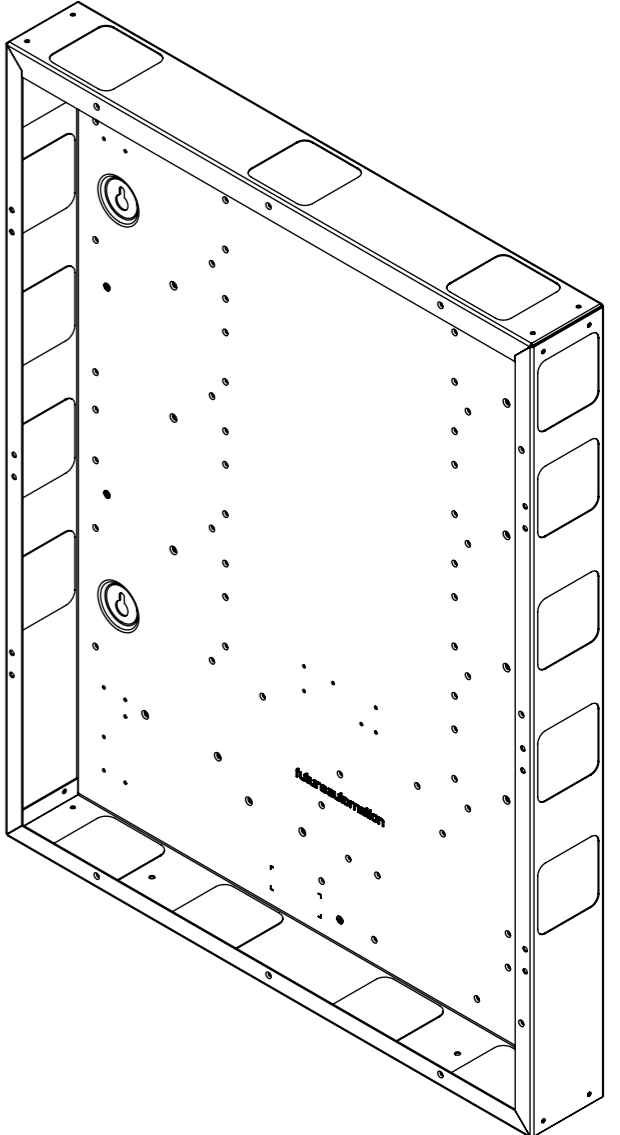
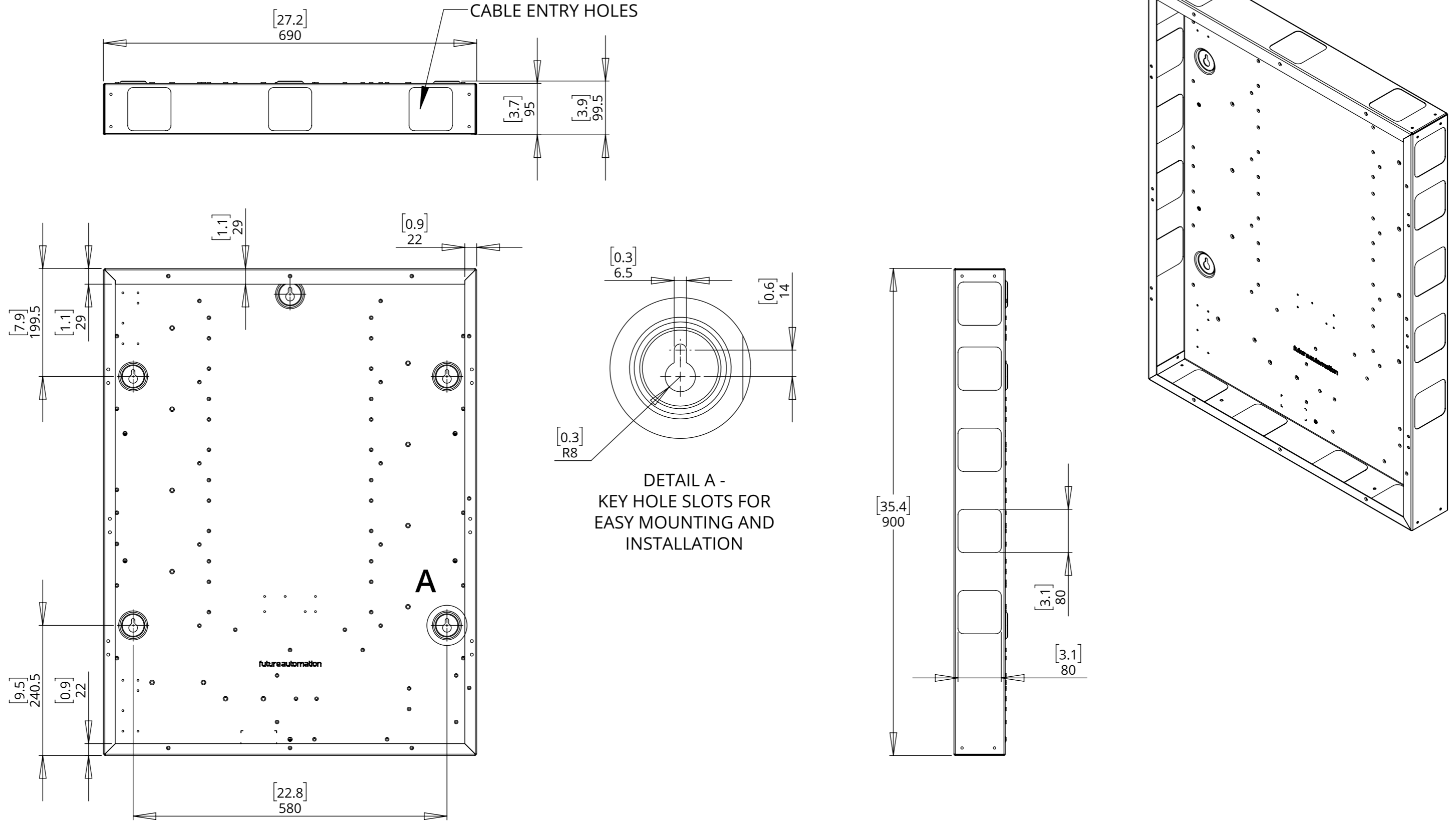

LCP5

LUTRON CONTROL PANEL - 5 RAIL

OVERALL DIMENSIONS

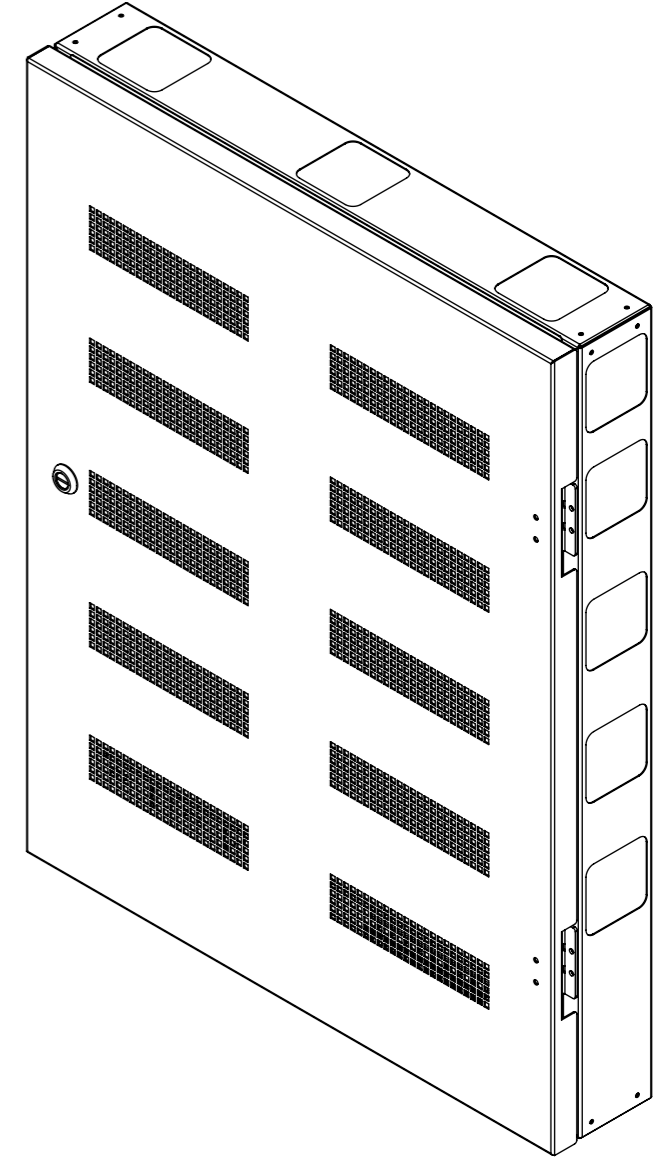
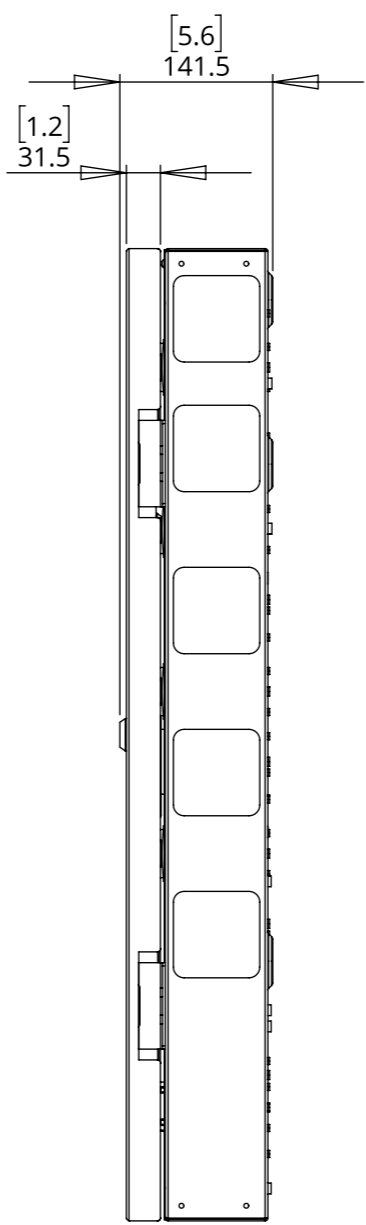
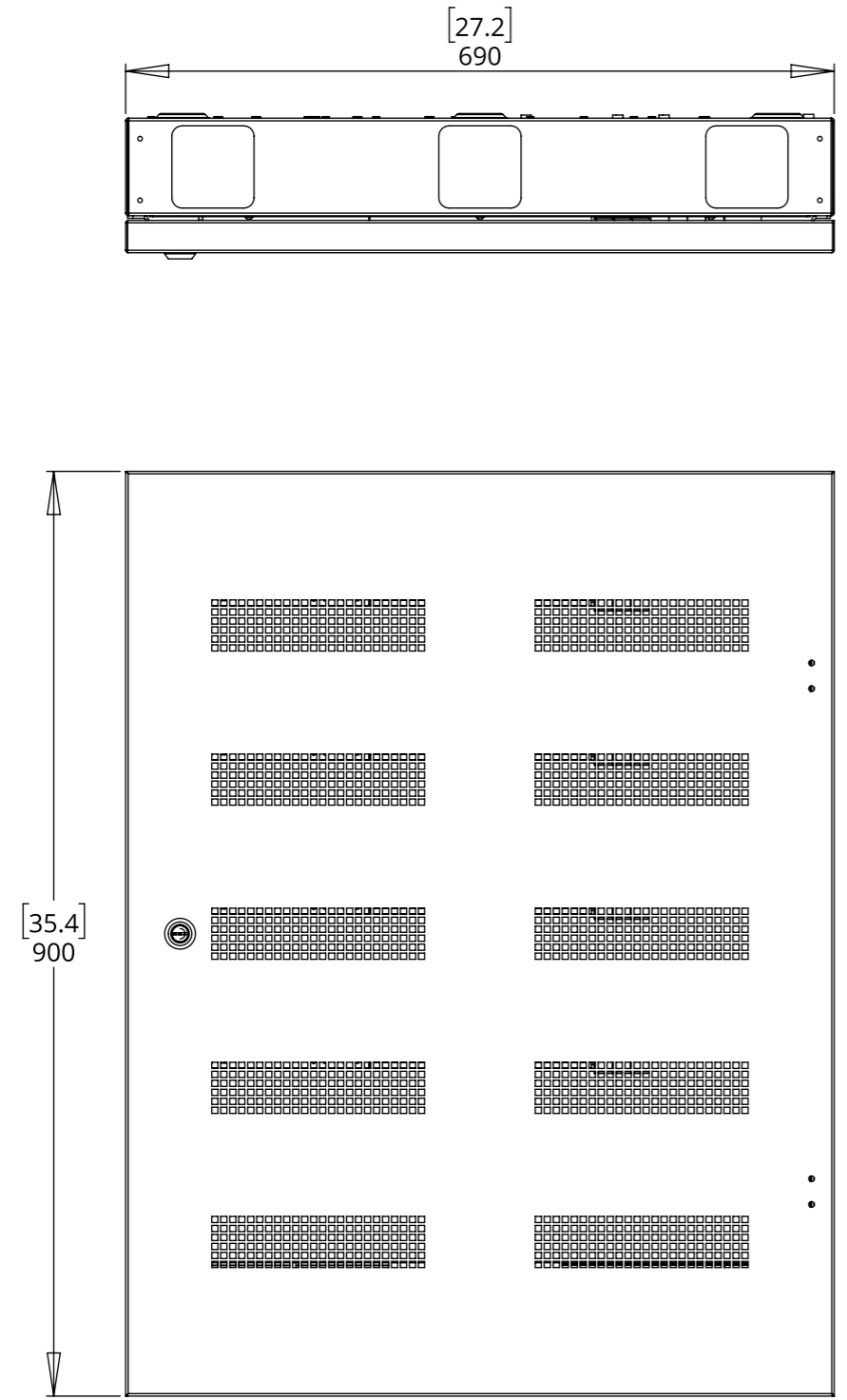

LCP5

LUTRON CONTROL PANEL - 5 RAIL



REVERSIBLE DOOR OVERVIEW

Door shown opening towards the right hand side

In order to switch to left hand side opening, simply remove front cover panel and swap latch plate and hinge outers over.

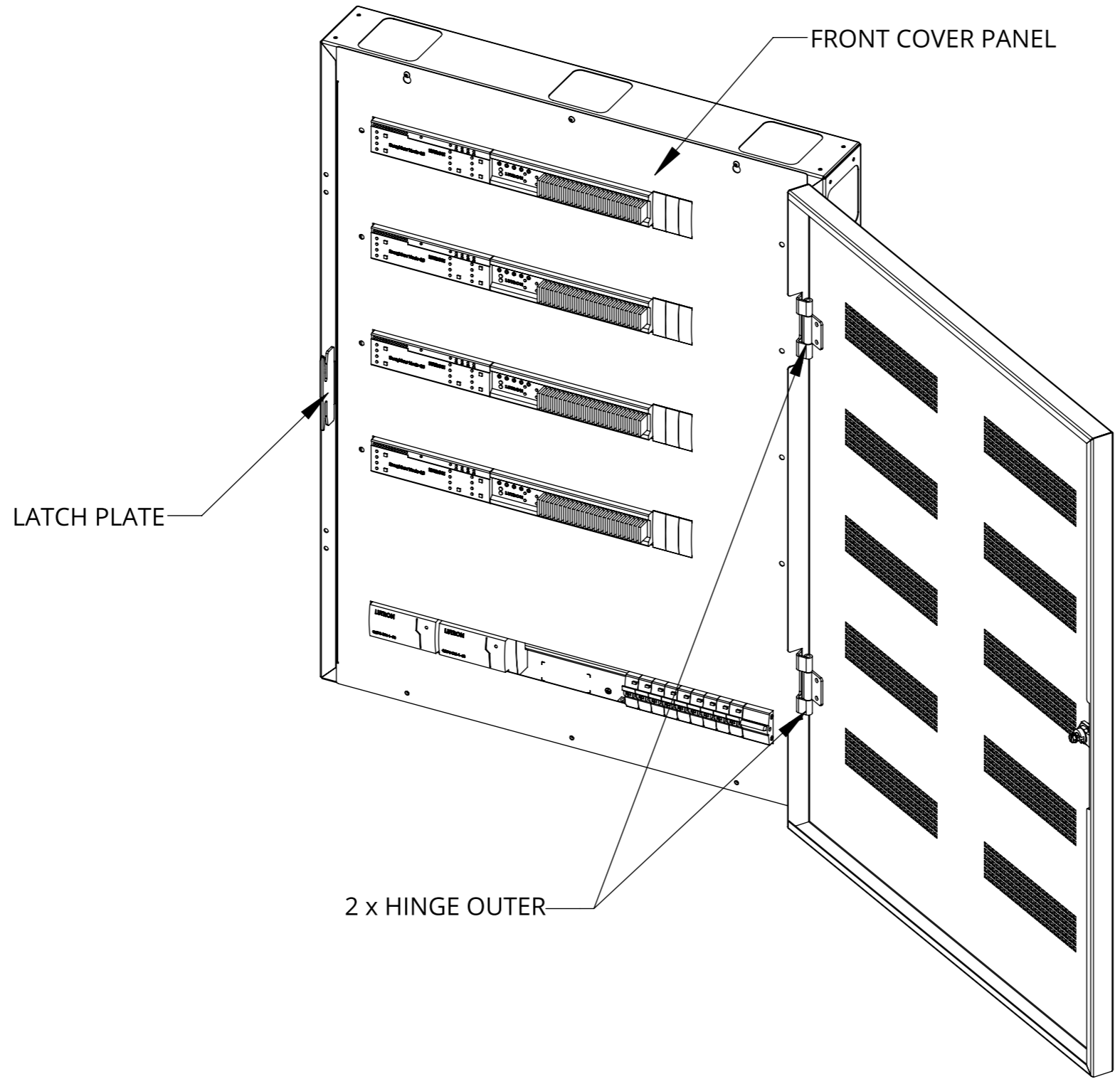

LCP5 LUTRON CONTROL PANEL - 5 RAIL

PANEL BOX LAYOUT

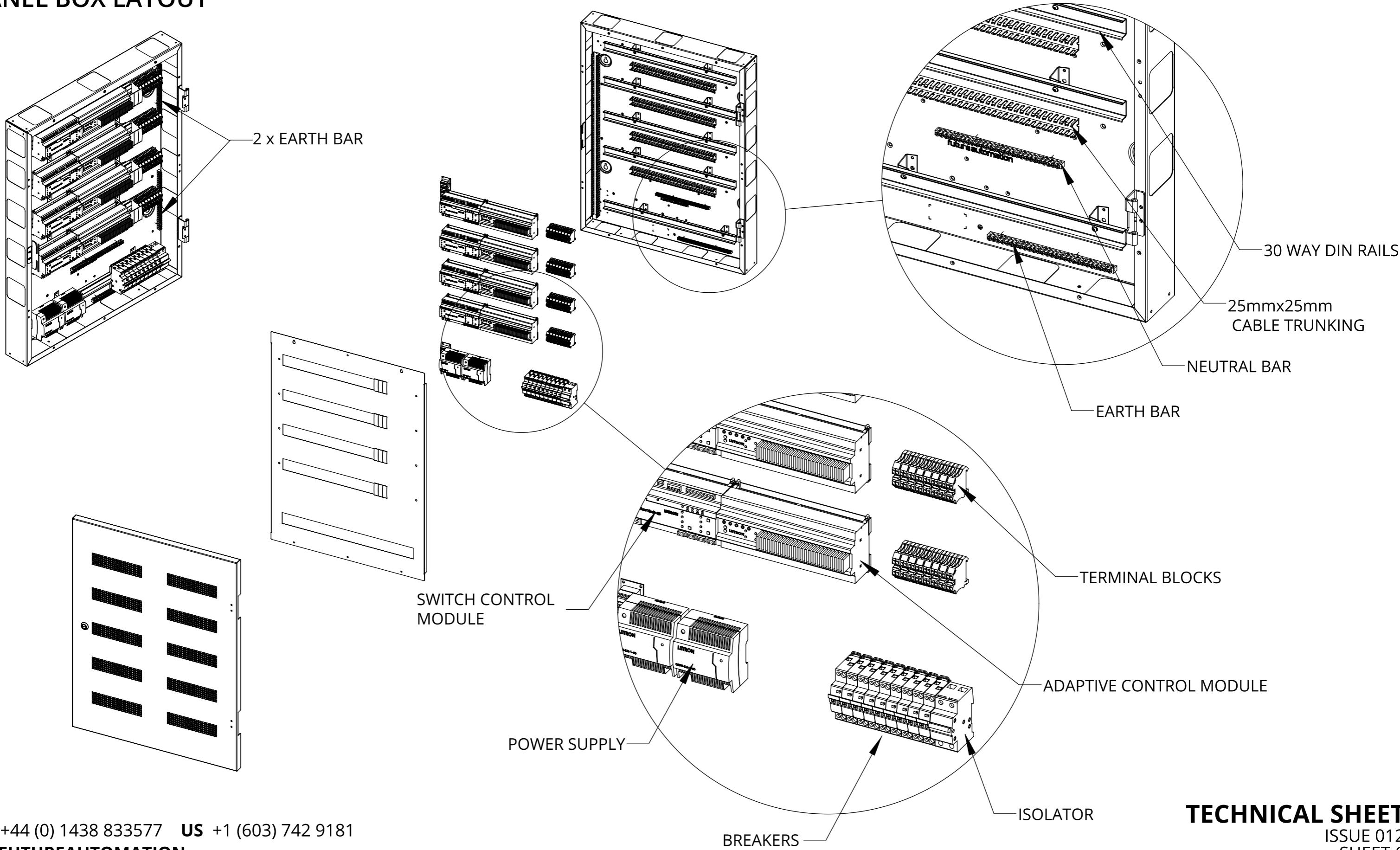

LCP5

LUTRON CONTROL PANEL - 5 RAIL

PANEL BOX LAYOUT

