

## UGR19 LED Panel light Specification



### Features

- Choose high bright brand LED source panel, LM80 B10 standard,SDCM<3;
- Choose brand driver, such as Philips, Osram, Tridonic, LIFUD,etc;
- CCT 3000K, 4000K, 5000K, 6000K, precise to  $\pm 100\text{K}$ ;
- Triac, 1-10V, DALI, CCT dimming available to choose;
- Hanging, mounted, spring clips installation can choose;
- All product include materials strictly by CE, RoHS certificated

**Application:** Office, Conference&Meeting rooms, Supermarket, Shopping mall, Hotel, Hospital,Commercial Center etc.

## LED panel light raw material features



### Steel material frame

- 0.3mm thickness
- 850g net weight

### EVA foam

- keep the LGP tightly to achieve
- a smoothly brightness

### Mitsubishi acrylic(PMMA)

- light guide plate, best quality, no yellow

### Diffuser plate

- A quality level,1.5mm thickness,
- light transmittance 98%

### Aluminum frame

- Net weight 435g (600x600mm)
- strong with good heat dissipation

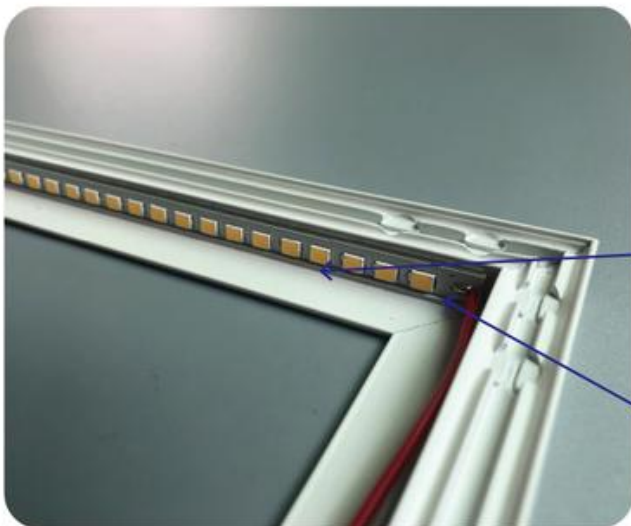

### LEDs

- Taiwan Epistar SMD2835 (SMD4014)
- LM80 standard
- High brightness 160lm/W

### PCB

- Heat dissipation coefficient 1.0

## AATECH LED LIGHTING COMPANY

Add: A building, Liangxiang industrial park, Fuqian road, Guanlan, Shenzhen, China

Website: [www.aatechled.com](http://www.aatechled.com) / [www.forisingled.com](http://www.forisingled.com)

Email: [info@aatechled.com](mailto:info@aatechled.com) / [info@forisingled.com](mailto:info@forisingled.com)

## Parameter

Input	DC24V
Colour temp.	3000K/4000K/6000K
LM	110lm/W
CRI	80
LEDs	SMD2835
LGP	PMMA
Driver	No
Dimming	No
UGR	<19
PF	0.90
THD	<15
Flicker	No
Beam angle	120°
Energy efficiency	A+
IP grade	40
Working temp.	-20°C ~ +40°C

## Item information

Dimensions(mm)	Model No.	Power	Lumens	CRI
295x595x11	AAPL-3060-20W-UGR	20W	2000lm	80
295x1195x11	AAPL-3012-40W-UGR	40W	80	
595x595x11	AAPL-6060-40W-UGR	40W	4000lm	80
1195x595x11	AAPL-6012-60W-UGR	60W	6000lm	80

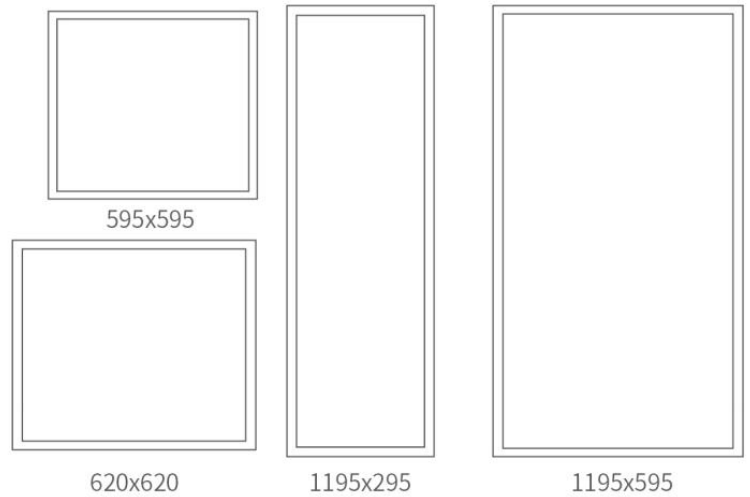

## LLUMINOUS INTENSITY DISTRIBUTION DIAGRAM

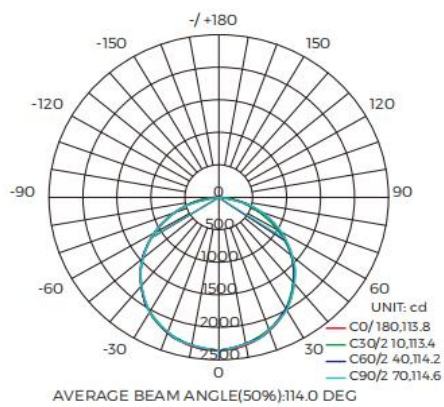

## C0 PLANE ISOLUX DIAGRAM (UNIT:lx)

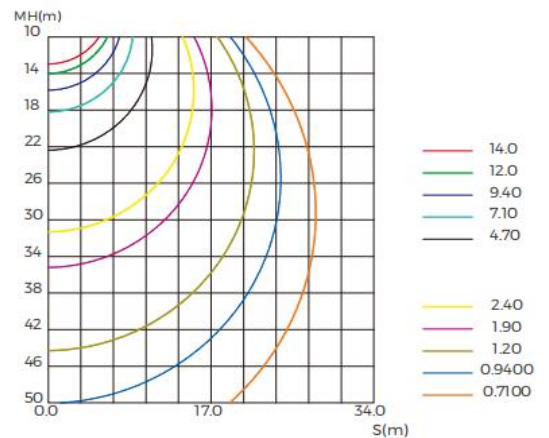

## Flexibility

- Different dimming version available (Triac, 1-10V, DALI, CCT dimming)
- Emergency battery version available

Standard version

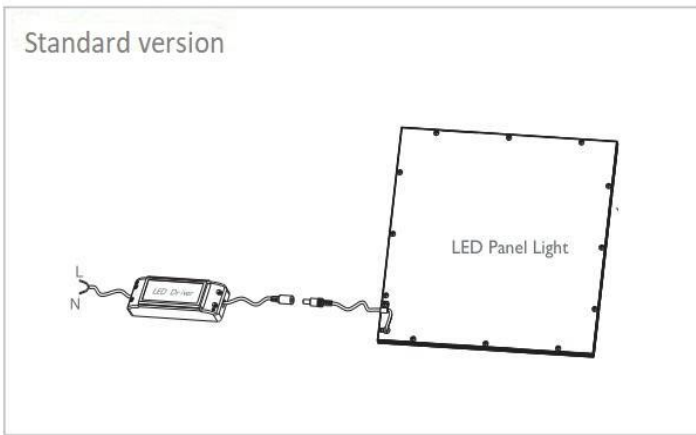

0-10V(1-10V) dimming version

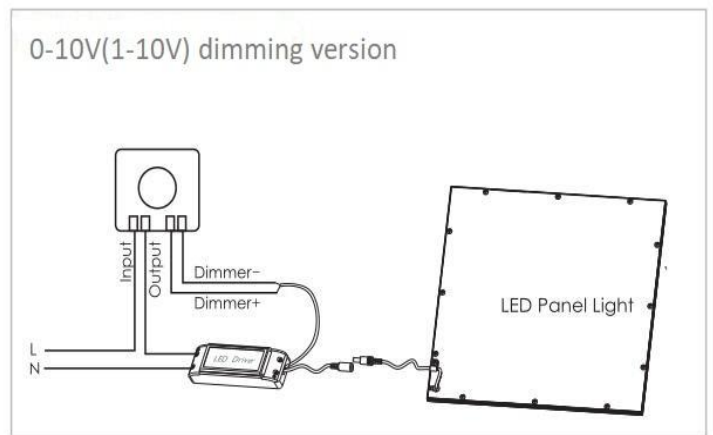

Triac dimming version

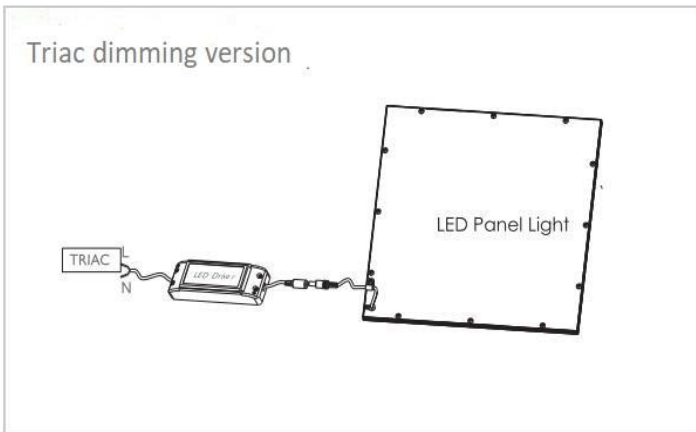

with emergency kit version

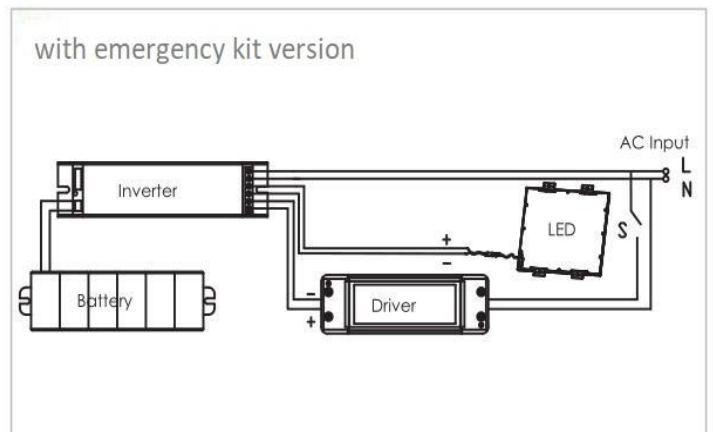

## Installation

### -Recessed installation step

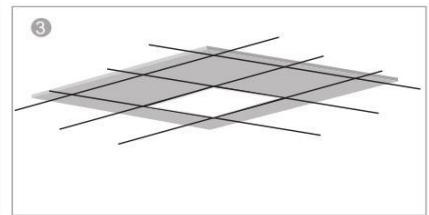
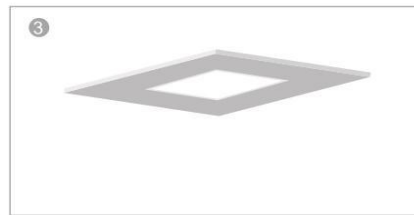
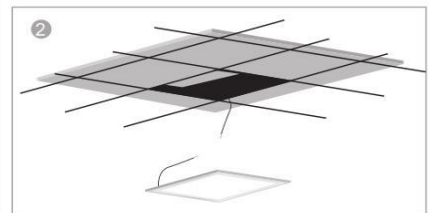
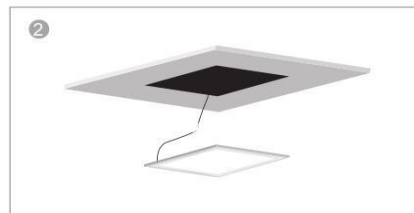
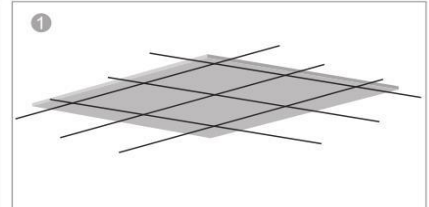
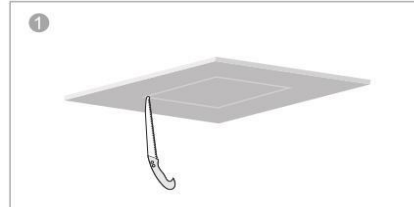

### -Hanging installation step

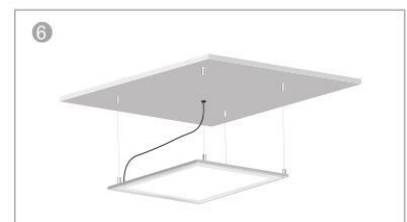
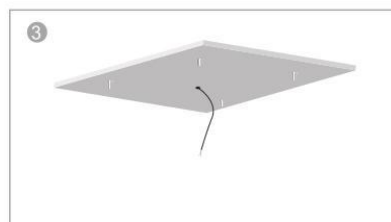
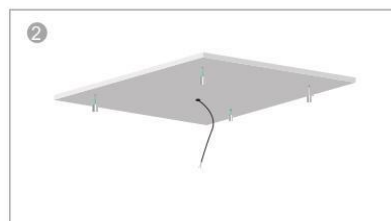
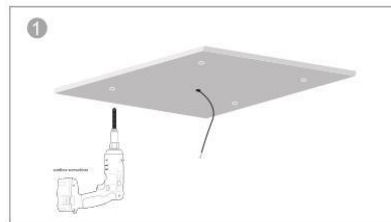

### -Mounted installation step

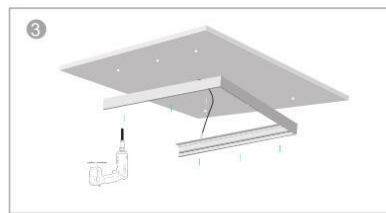
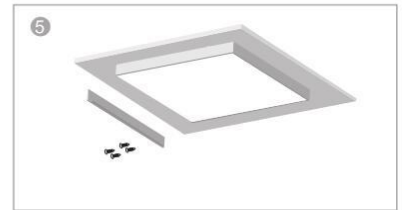
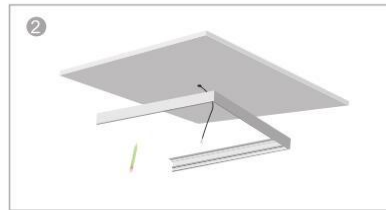
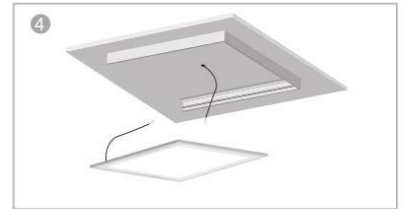
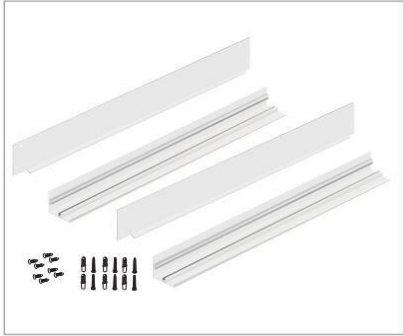

### -Spring clips installation step

