

SEAMLESS



TRIMLESS GHOST
PLASTER DOWNLIGHTS





Trimless Ghost downlights are made from plaster with a beautiful smooth finish.

These downlights can be installed into both finished skimmed ceilings or new ceilings that have not been skimmed yet. The finished installation is completely seamless where the downlights blends in perfectly with the ceiling.

CONTENTS

Trimless Ghost Overview	2
Trimless Ghost Plaster Round	3
Trimless Ghost Plaster Square	7
Trimless Ghost Micro Pinhole	9
LED Lamps & Modules	11
Trimless Ghost Plaster Installation	15



TRIMLESS GHOST PLASTER DOWNLIGHTS

Adjustable Clips
To fit any plaster board depth

White Plaster
Appears part of the ceiling,
also easy to paint

**Can be installed
into plastered ceilings**
Simply cut holes and fill
the gaps

Seamless Look
Plaster to lip for a
seamless modern look

Anti-Glare
Deep body gives a glare free
invisible look

TRIMLESS GHOST PLASTER ROUND



Round Sharp Edge Fixed

Order Code	Colour	Lampholder	Voltage	Wattage	IP Rating	Adjustable Clips
SEAD0178A GU10 W	WHITE	GU10	240V	50W	IP20	YES

To make this fitting fire-rated, use our Fire Hood. Order code : **HOOD DLC4**

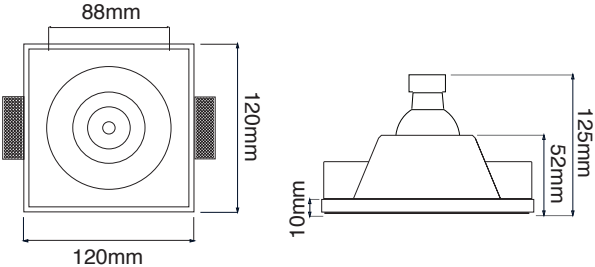

Round Sharp Edge Adjustable

Order Code	Colour	Lampholder	Voltage	Wattage	IP Rating	Adjustable Clips
SEAD0121 GU10 WH	WHITE	GU10	240V	50W	IP20	YES

To make this fitting fire-rated, use our Fire Hood. Order code : **HOOD DLC4**

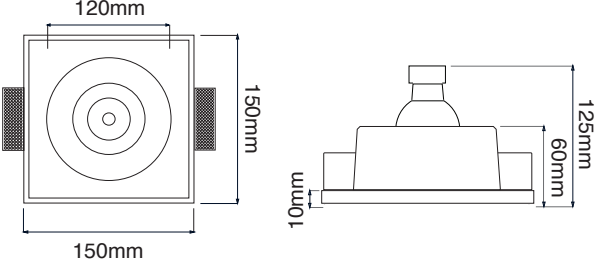

TRIMLESS GHOST PLASTER ROUND



Round Soft Edge Fixed

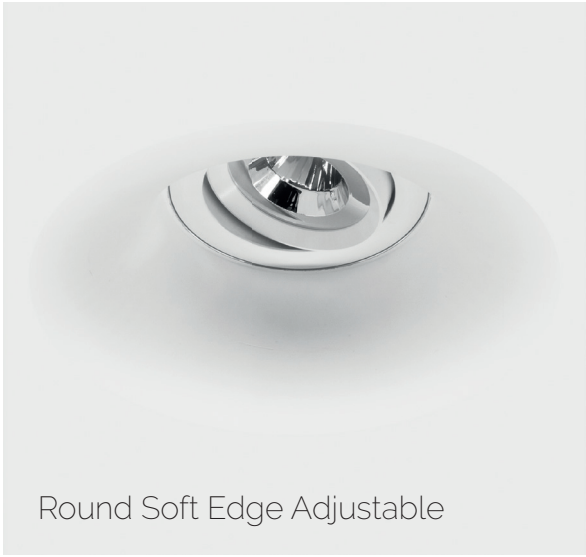

Round Soft Edge Adjustable

Round Soft Edge Fixed

Order Code	Colour	Lampholder	Voltage	Wattage	IP Rating	Adjustable Clips
SEAD0190 GU10 WH	WHITE	GU10	240V	50W	IP20	YES

To make this fitting fire-rated, use our Fire Hood. Order code : **HOOD DLC4**

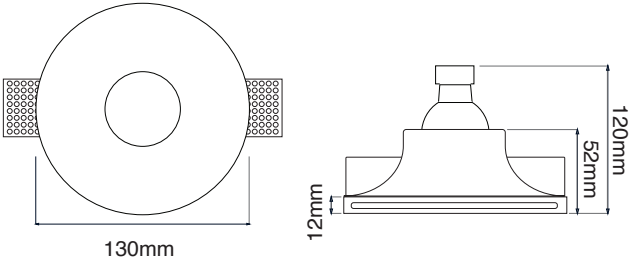

Round Soft Edge Adjustable

Order Code	Colour	Lampholder	Voltage	Wattage	IP Rating	Adjustable Clips
SEAD0118 GU10 WH	WHITE	GU10	240V	50W	IP20	YES

To make this fitting fire-rated, use our Fire Hood. Order code : **HOOD DLC4**

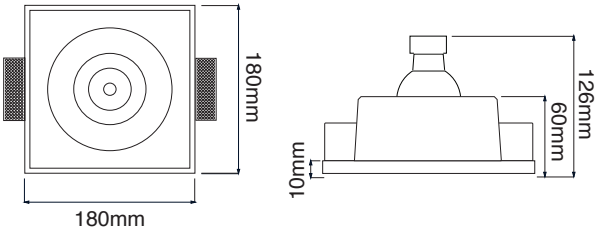

TRIMLESS GHOST PLASTER ROUND



Large Round Fixed Single

Order Code	Colour	Lampholder	Voltage	Wattage	IP Rating	Adjustable Clips
SEA1026 QR111 WH	WHITE	G53 / AR111	12V	100W	IP20	NO

To make this fitting fire-rated, use our Fire Hood. Order code : **FRT100 QR111HOOD**

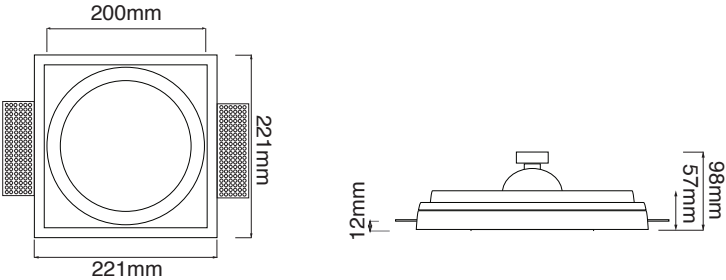

TRIMLESS GHOST PLASTER ROUND



Large Round Fixed Double



Large Round Fixed Triple

Large Round Fixed Double

Order Code	Colour	Lampholder	Voltage	Wattage	IP Rating	Adjustable Clips
SEA1027 QR111 WH	WHITE	G53 / AR111	12V	2 x 100W	IP20	NO

To make this fitting fire-rated, use our Fire Hood. Order code : **FRT200 QR111HOOD**

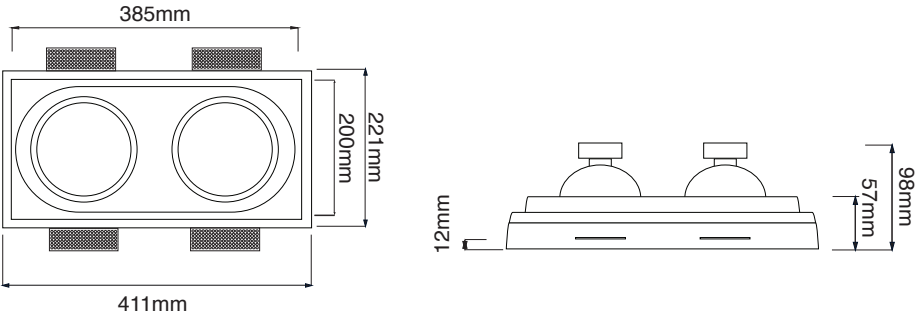

Large Round Fixed Triple

Order Code	Colour	Lampholder	Voltage	Wattage	IP Rating	Adjustable Clips
SEA1028 QR111 WH	WHITE	G53 / AR111	12V	3 x 100W	IP20	NO

To make this fitting fire-rated, use our Fire Hood. Order code : **FRT300 QR111HOOD**

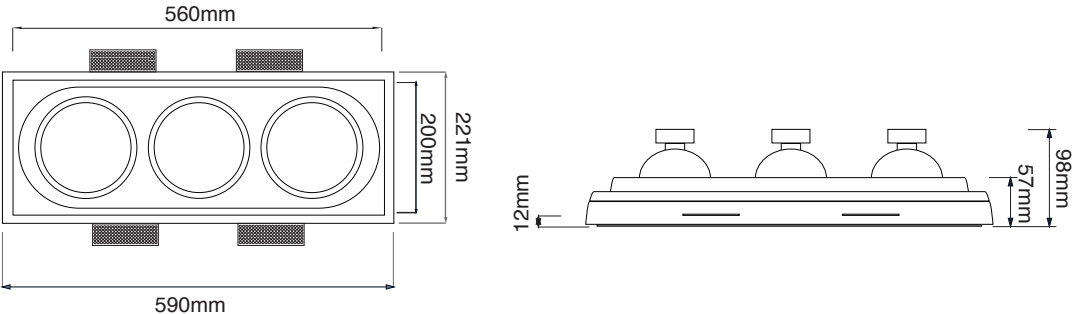

TRIMLESS GHOST PLASTER SQUARE



Square Fixed



Square Fixed 45° Angle

Square Fixed

Order Code	Colour	Lampholder	Voltage	Wattage	IP Rating	Adjustable Clips
SEAD0177A GU10 W	WHITE	GU10	240V	50W	IP20	YES

To make this fitting fire-rated, use our Fire Hood. Order code : **HOOD DLC4**

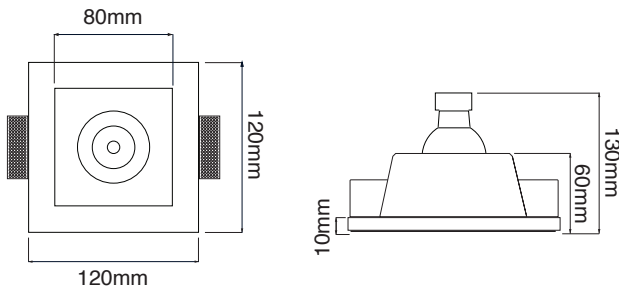

Square Fixed 45° Angle

Order Code	Colour	Lampholder	Voltage	Wattage	IP Rating	Adjustable Clips
SEAD0184 GU10 WH	WHITE	GU10	240V	50W	IP20	YES

To make this fitting fire-rated, use our Fire Hood. Order code : **HOOD DLC4**

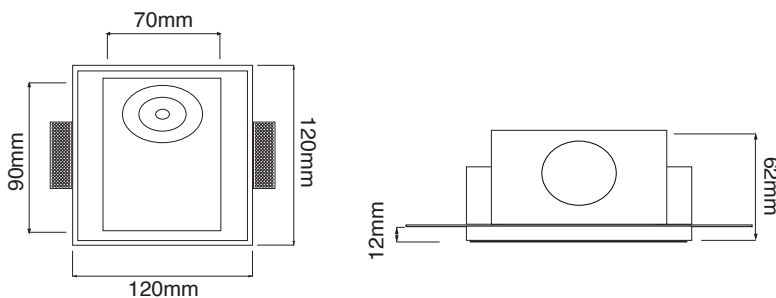

TRIMLESS GHOST PLASTER SQUARE

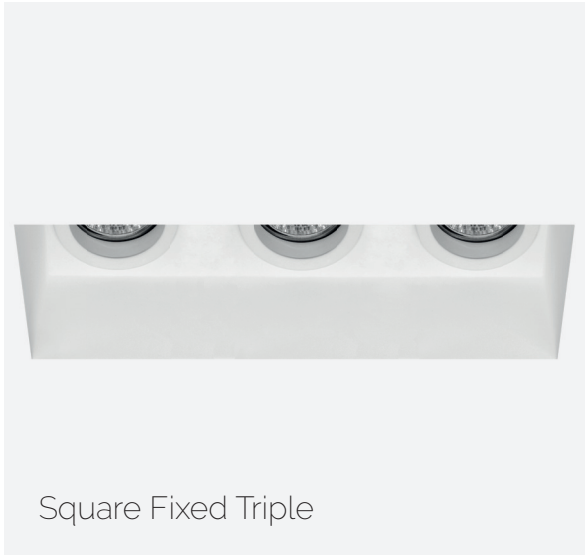
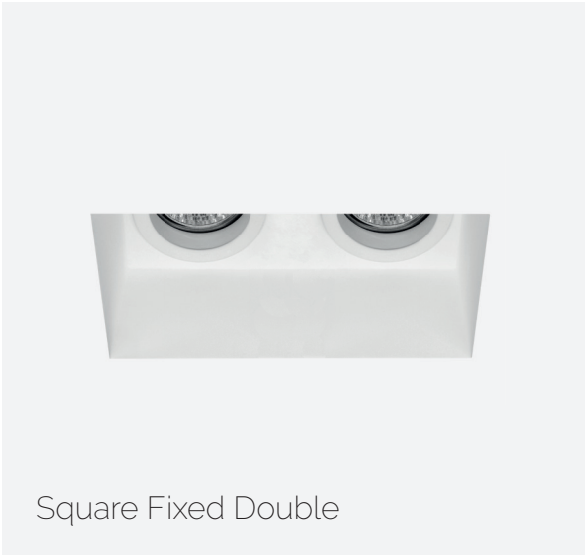

Square Fixed Double

Order Code	Colour	Lampholder	Voltage	Wattage	IP Rating	Adjustable Clips
SEAD0191 GU10 WH	WHITE	GU10	240V	2 x 50W	IP20	YES

To make this fitting fire-rated, use our Fire Hood. Order code : **FRT200 MR16HOOD**

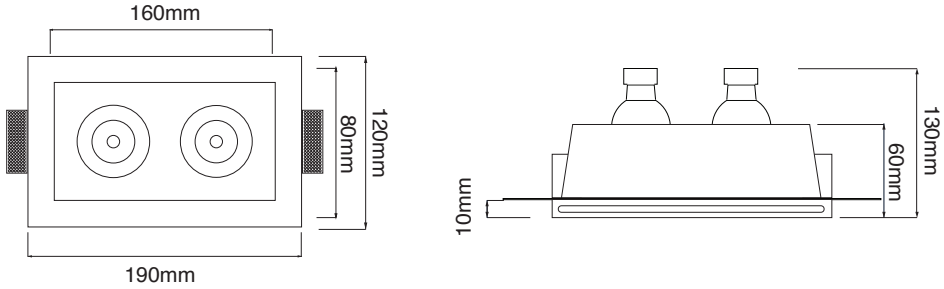

Square Fixed Triple

Order Code	Colour	Lampholder	Voltage	Wattage	IP Rating	Adjustable Clips
SEA1003 GU10 WHT	WHITE	GU10	240V	3 x 50W	IP20	NO

To make this fitting fire-rated, use our Fire Hood. Order code : **FRT300 MR16HOOD**

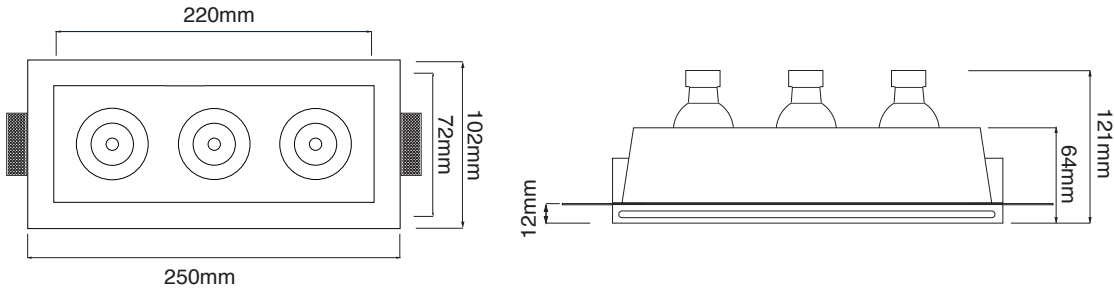

TRIMLESS GHOST MICRO PINHOLE



Pinhole Fixed LED with Driver

Order Code	Colour	Lampholder	Voltage	Wattage	IP Rating	Adjustable Clips
SEAD0186 WH	WHITE	NON	240V	1W	IP20	YES

To make this fitting fire-rated, use our Fire Hood. Order code : **HOOD DLC4**

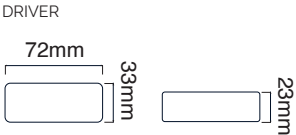
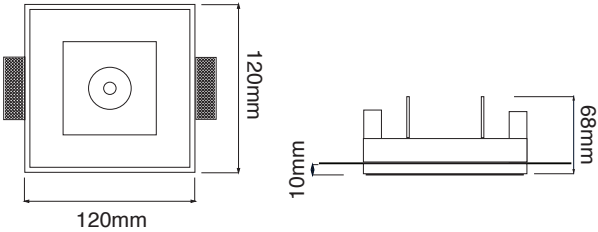



REALITY LED LAMPS



LED REALITY GU10 RETRO - 50mm

Order Code	Wattage	Colour Temp	Lumens	Beam angle	CRI	Lamp Holder	Dimmable
REAL RETRO5 I24D	5W	2700K	500	24°	80	GU10	Yes
REAL RETRO5 W24D	5W	3000K	500	24°	80	GU10	Yes
REAL RETRO5 I45D	5W	2700K	500	45°	80	GU10	Yes
REAL RETRO5 W45D	5W	3000K	500	45°	80	GU10	Yes



LED REALITY GU10 TALL - 50mm

Order Code	Wattage	Colour Temp	Lumens	Beam angle	CRI	Lamp Holder	Dimmable
REAL GU10D INT24	7W	2700K	630	24°	80	GU10	Yes
REAL GU10D 24D	7W	3000K	630	24°	80	GU10	Yes
REAL GU10D INT45	7W	2700K	630	45°	80	GU10	Yes
REAL GU10D 45D	7W	3000K	630	45°	80	GU10	Yes



LED REALITY MODULE - 50mm

Order Code	Wattage	Colour Temp	Lumens	Beam angle	CRI	Lamp Holder	Dimmable
REAL MODULE 24/I	10W	2700K	900	24°	80	-	Yes
REAL MODULE 24/W	10W	3000K	900	24°	80	-	Yes
REAL MODULE 45/I	10W	2700K	900	45°	80	-	Yes
REAL MODULE 45/W	10W	3000K	900	45°	80	-	Yes

REALITY LED LAMPS



LED REALITY MODULE 25 - 50mm

Order Code	Wattage	Colour Temp	Lumens	Beam angle	CRI	Lamp Holder	Dimmable
REAL 25MM 45/I	7W	2700K	650	45°	80	-	Yes
REAL 25MM 45/W	7W	3000K	650	45°	80	-	Yes



LED REALITY AR111 & Driver - 110mm

Order Code	Wattage	Colour Temp	Lumens	Beam angle	CRI	Lamp Holder	Dimmable
REAL AR111 INTK	13W	2700K	950	24°	80	G53 / AR111	Yes
REAL AR111 WWK	13W	3000K	950	24°	80	G53 / AR111	Yes
REAL AR111D C/W	13W	4000K	950	24°	80	G53 / AR111	Yes

RGBW LED MODULES



RGBW LED MODULE - 50mm

Order Code	Wattage	Voltage	White Temp	Beam angle	CRI	Lamp Holder	Dimmable
LEDMODULE RGBWS9	8.5W	24V	3000K	45°	80	-	Yes



RGBW LED MODULE - 110mm

Order Code	Wattage	Voltage	White Temp	Beam angle	CRI	Lamp Holder	Dimmable
LEDMODULE RGBW L	16W	24V	3000K	45°	80	-	Yes
LEDMODULE RGBC L	16W	24V	4000K	45°	80	-	Yes

ACCESSORIES

Power Cord 1m	LEDMODULE RGBWC1
End Cap	LEDMODULE RGBWEC
2M Coupler Lead	LEDMODULE RGBW02
5M Coupler Lead	LEDMODULE RGBW05
10M Coupler Lead	LEDMODULE RGBW10
25W 24V LED Driver	RS2524
50W 24V LED Driver	RS5024
100W 24V LED Driver	RS10024
150W 24V LED Driver	RS15024
Wise RGBW Receiver	WISERGBW SCENE
Wise Intense Wireless Keypad	WISE INTENSE7 WH

DYNAMIC WHITE LED MODULES



DYNAMIC WHITE LED MODULE - 50mm

Order Code	Wattage	Voltage	White Temp	Beam angle	CRI	Lamp Holder	Dimmable
DYN MODULE MR16	8.5W	24V	2700K - 6500K	45°	80	-	Yes



DYNAMIC WHITE LED MODULE - 110mm

Order Code	Wattage	Voltage	White Temp	Beam angle	CRI	Lamp Holder	Dimmable
DYN MODULE AR111	12W	24V	2700K - 6500K	75°	80	-	Yes

ACCESSORIES

Power Cord 1m	DYNPC1
End Ca	DYNEND
2M Coupler Lead	DYN2M
5M Coupler Lead	DYN5M
10M Coupler Lead	DYN10M
25W 24V LED Driver	RS2524
50W 24V LED Driver	RS5024
100W 24V LED Driver	RS10024
150W 24V LED Driver	RS15024
Wise Dynamic White Receiver	WISEDYN STRIP
Wise Intense Wireless Keypad	WISE INTENSE7 WH

INSTALLING TRIMLESS GHOST PLASTER DOWNLIGHTS

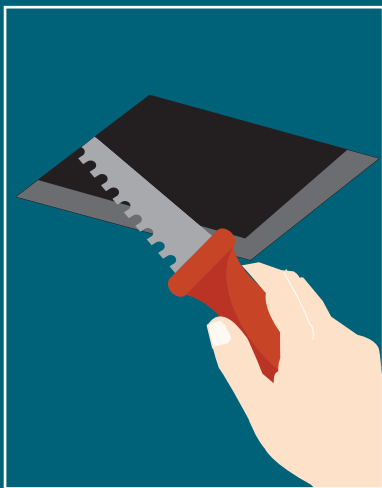

1.

cut hole in
ceiling

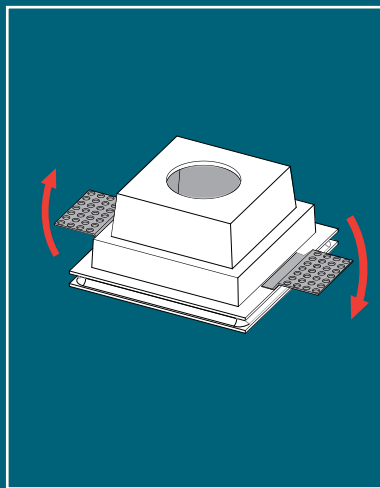

2.

adjust clips to
depth of
plaster board

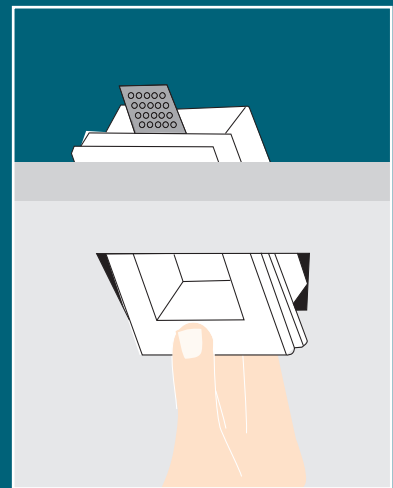

3.

position
downlight
flush to ceiling

Trimless Ghost Plaster Downlights can be installed in plaster board or plastered ceilings. Simply cut out the hole, fit, fill the gaps and sand.

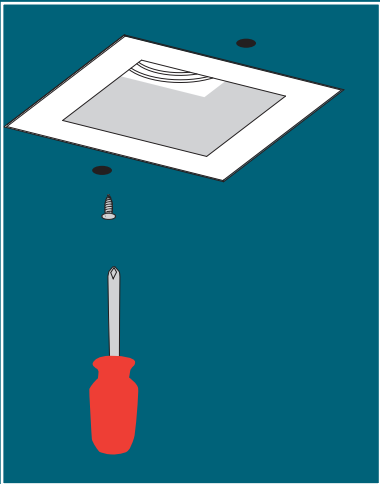

4.
fix with screws

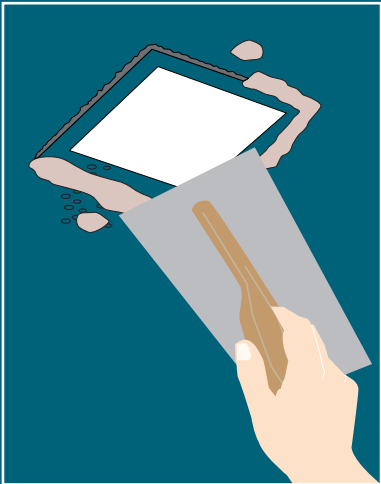

5.
fill gaps with
plaster or filler



6.
fit lamp

020 8874 2234 | info@mr-resistor.co.uk

19 - 23 Lydden Road, Wandsworth, London, SW18 4LT, United Kingdom

www.mr-resistor.co.uk

