



SLIMDUET system

SLIMDUET

Ultimate slim, perfect style

Innovative slim linear connecting system, a perfect combination between tracks and LED fixtures.

Not only emphasizing on characteristics and rapid installation of the modules, also creates simple and clean appearance.

Unique designed spot, panel and downlight modules are available for multitasking lighting requirement to the area.

This is a perfect solution to maximize lighting creativity.

SLIMDUET

SLIMDUET TRACK

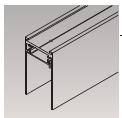

SDT

Surface mounted & Pendant track

P.15

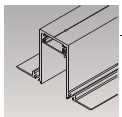

SDR

Trimless recessed track

P.15

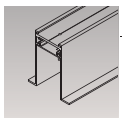

SDF

Trim recessed track

P.15

SLIMDUJET MODULES

		Series name	LED Consumption	Lumen	
		SLIMDUJET-K	11W 22W 33W	1000 (lm) 2000 (lm) 3000 (lm)	P.23
		SLIMDUJET-P	9.2W 18.4W 27.5W	472 (lm) 1197 (lm) 1428 (lm)	P.25
		SLIMDUJET-W	11W	462 (lm)	P.27
		SLIMDUJET-S	6.4W 12.7W	626 (lm) 1114 (lm)	P.29
		SLIMDUJET-GR	5.3W	100 (lm)	P.31
		SLIMDUJET-GL	5.3W	399 (lm)	P.33
		SLIMDUJET-C	6.4W	626 (lm)	P.35
		SLIMDUJET-KC	22W	2000 (lm)	P.37
		SLIMDUJET-KS	11W	1000 (lm)	P.39



SLIMDUET

Slim linear connecting system, can be recessed, surface mounted or pendant. Suitable for all kinds of interior environment.

The LED modules are designed with simple linear style, each series perform its own function, making lighting design easier than ever.

SLIMDUET

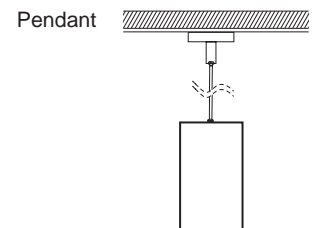
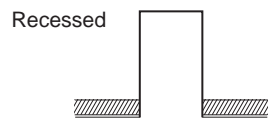
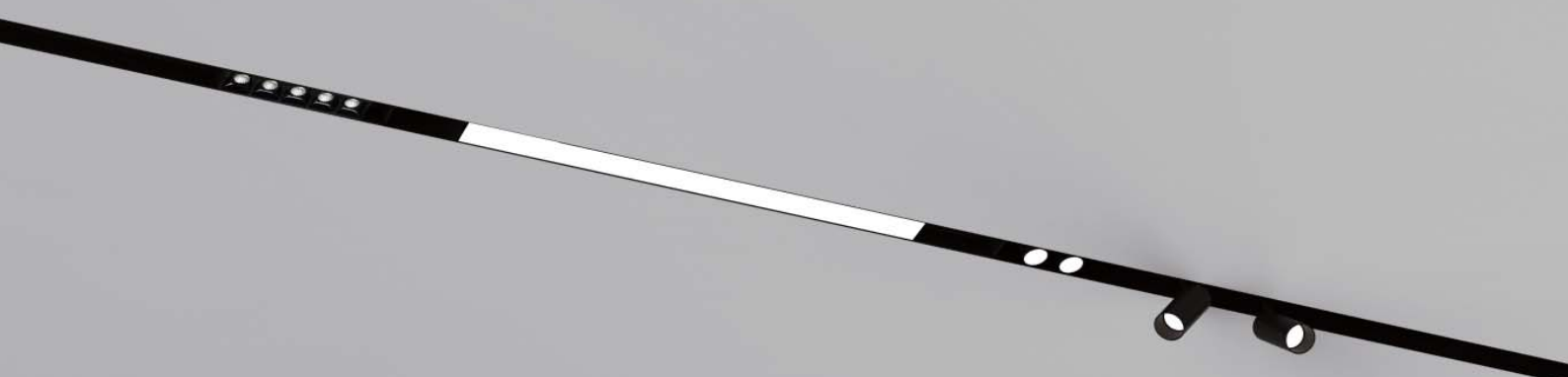

SLIMDUET

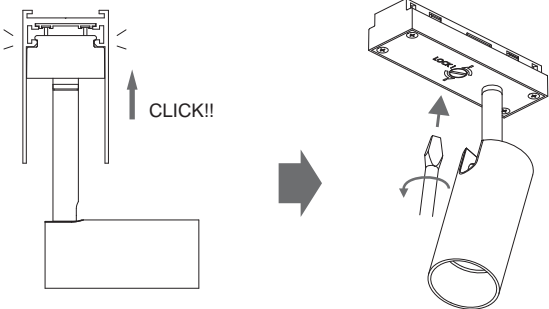

LED fixture installation is designed to be simple and convenient, just plug and play, tools-free, significant savings on installation and maintenance. The track cover can be moved or cut to fit with the LED fixture to make overall appearance succinct.

Track section

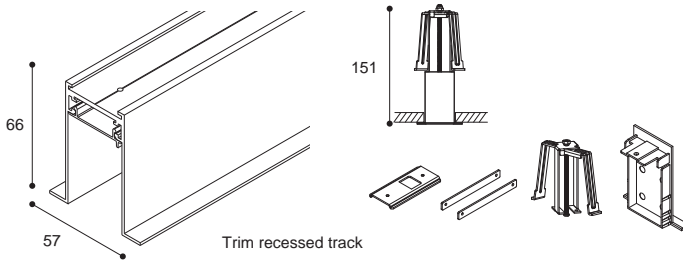
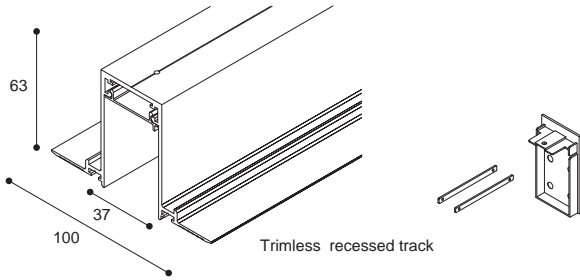
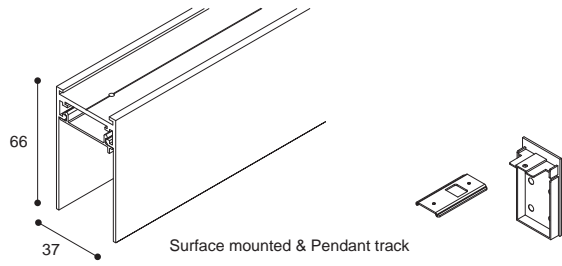

Product performance

Article number	L
SDT-01	1500mm
SDT-02	2100mm
SDT-03	2500mm

Article number	L
SDR-01	1500mm
SDR-02	2100mm
SDR-03	2500mm

Article number	L
SDF-01	1500mm
SDF-02	2100mm
SDF-03	2500mm

Colours  
Black White

Accessories

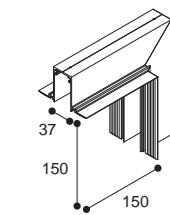

Article number: SDR-04
Type : Trimless recessed vertical corner

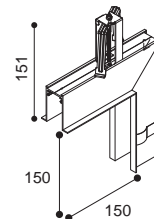

Article number: SDF-04
Type : Trim recessed vertical corner

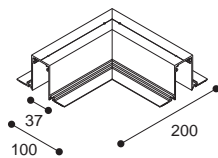
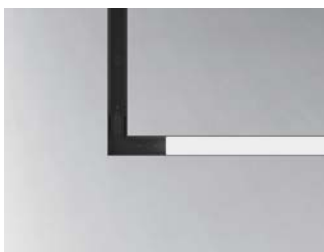

Article number : SDR-05
Type : Trimless recessed horizontal corner

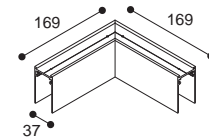

Article number : SDT-05
Type : Surface mounted & pendant horizontal corner

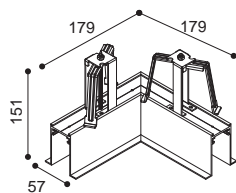

Article number : SDF-12
Type : Trim recessed horizontal corner

SLIMDUET (AM)

INSTALLATION GUIDE

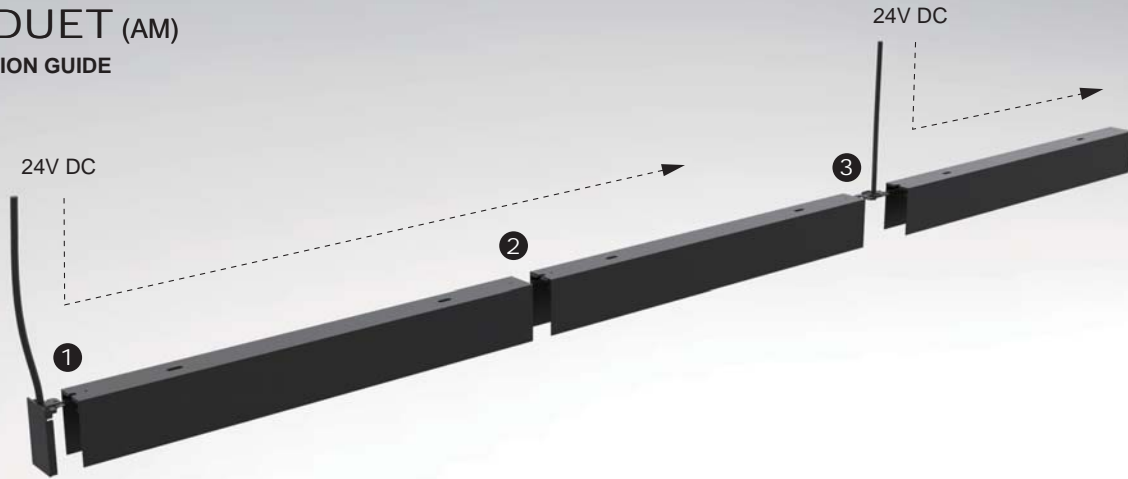

APPLICATION – connecting power in different conditions for continuous connection

1 Single Power, Single Track

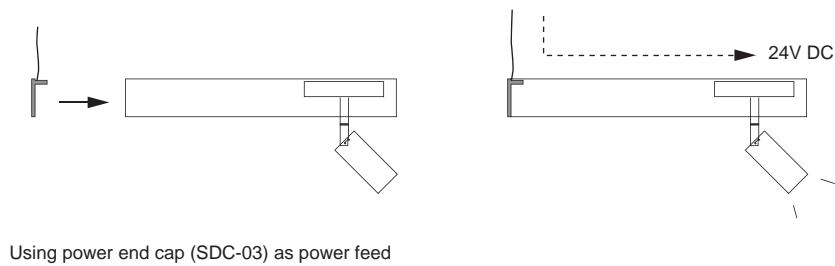
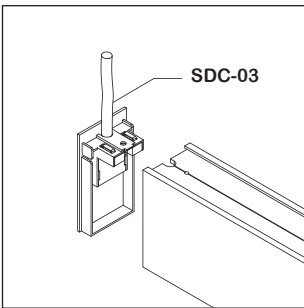

2 Single Power, Multiple Tracks

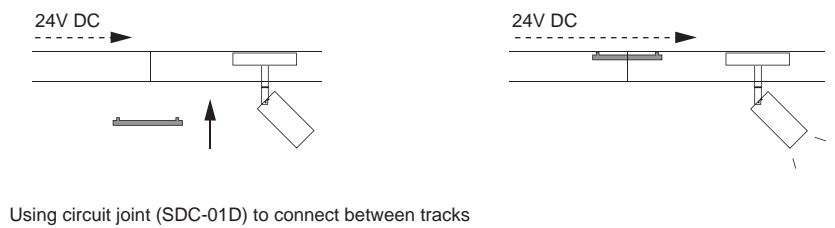
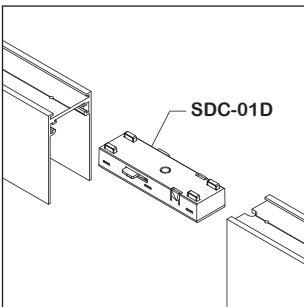

3 Multiple Powers, Multiple Tracks

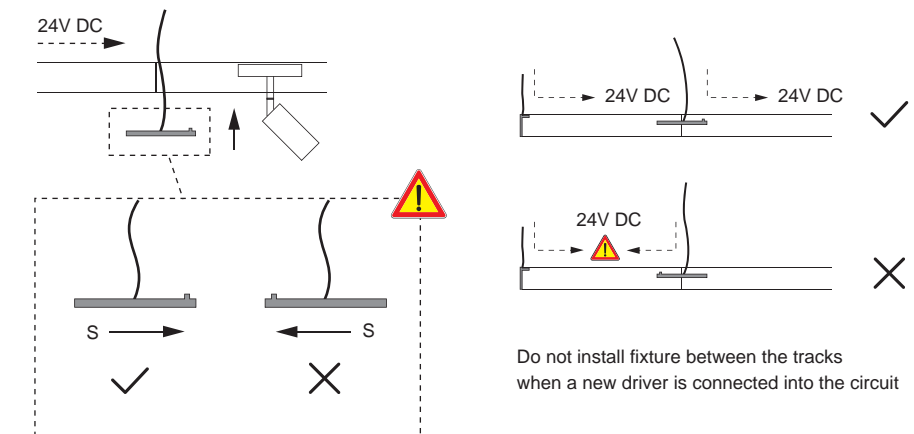
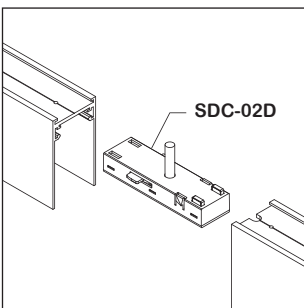

Using power joint (SDC-02D) to connect more drivers

ACCESSORIES

Connections

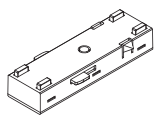

Article number : SDC-01D
Type : Circuit joint

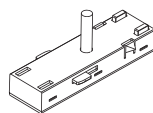

Article number : SDC-02D
Type : Power joint
Length : 200cm

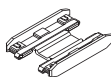

Article number : SDC-07D
Type : New circuit joint

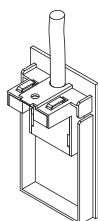

Article number : SDC-03
Type : Surface mounted & pendant & trimless
recessed end cap with power cord
Length : 200cm

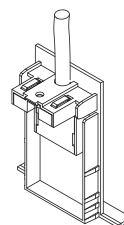

Article number : SDC-03A
Type : Trim recessed end cap
with power cord
Length : 200cm

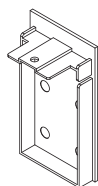

Article number : SDC-04
Type : Surface mounted & pendant & trimless
recessed end cap without power cord

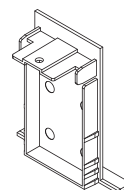

Article number : SDC-04A
Type : Trim recessed end cap
without power cord

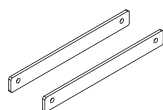

Article number : SDC-05
Type : Trim recessed & surface
mounted reinforced joint

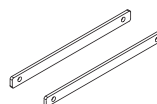

Article number : SDC-05A
Type : Trimless recessed
reinforced joint

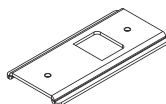

Article number : SDC-06
Type : Surface mounted & Pendant
reinforced plate

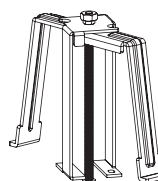

Article number : SDI-10
Type : Trim recessed clip

Pendant

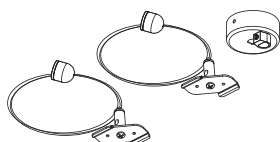

Article number : SDI-05
Type : Pendant kit for power connection
without power cord
Length : 150cm



Article number : SDI-06
Type : Pendant kit without
power cord
Length : 150cm

SLIMDUET

Application Illustration

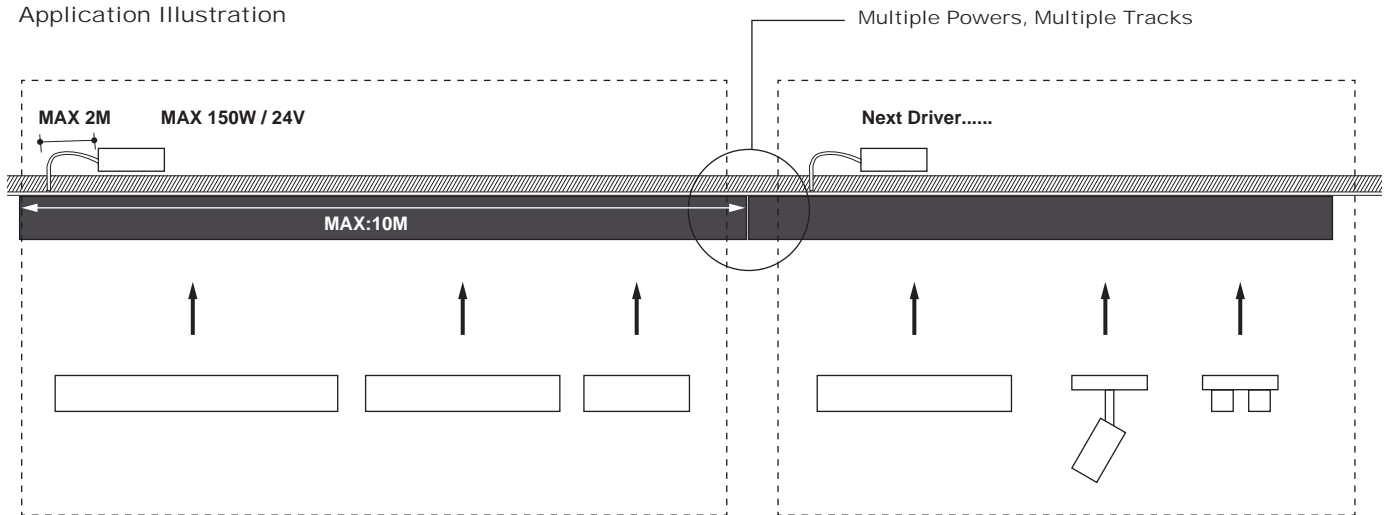

NOTE:

1. Max wattage linkable per loop for 24VDC is 150W.
2. Max length of track linkable per loop is 10M , and the max cable length between driver and track is 2M.
3. Dimming modules are compatible to PWM dimming driver only.
4. To use drivers not on recommended list , it require compatibility test before installation.

Tracks allows continuous linkable without limitation, also can divide into sections to light up individual area, making lighting application easy as 123.

Driver Installation

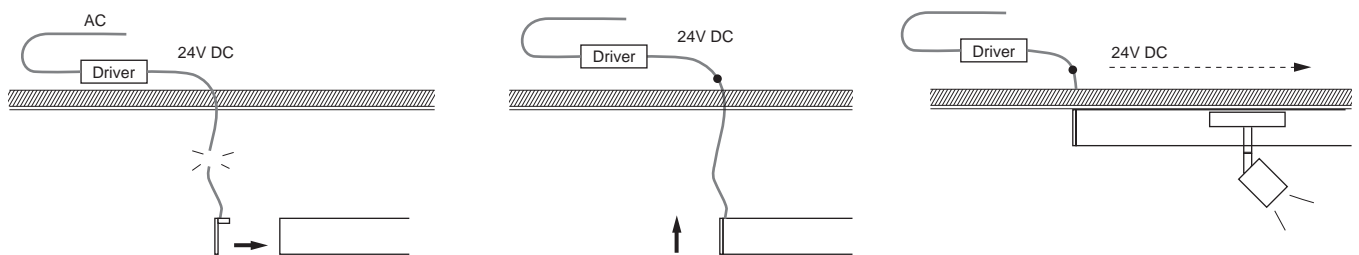

Driver needs to hide into the ceiling







SLIMDUET





SLIMDUET-K

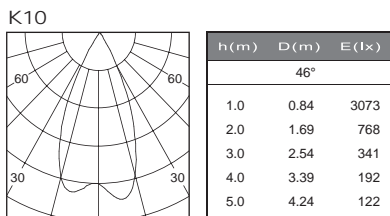
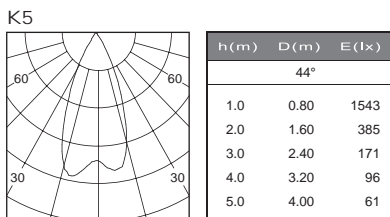
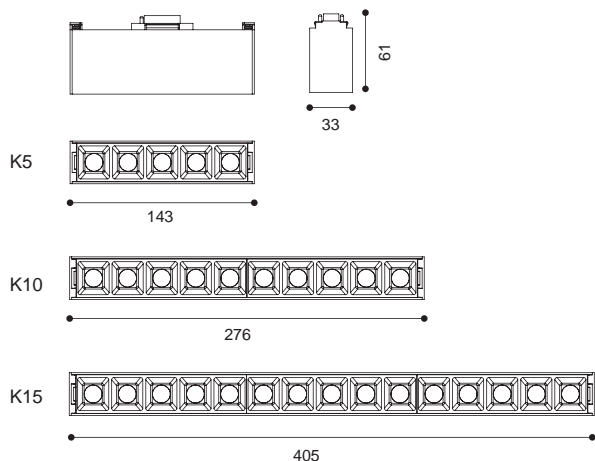

- Colours Black White
- Baffle : Black White Piano black

Product performance

SLIMDUET-K5

Article number	LED Consumption	Voltage	Lumen	Beam Angle	CCT/CRI	Locking Type
1817.406A-V	11W	24V DC	1000 (lm)	15°/30°/40°	30/90+	Push

SLIMDUET-K10

Article number	LED Consumption	Voltage	Lumen	Beam Angle	CCT/CRI	Locking Type
1817.406B-V	22W	24V DC	2000 (lm)	15°/30°/40°	30/90+	Push

SLIMDUET-K15

Article number	LED Consumption	Voltage	Lumen	Beam Angle	CCT/CRI	Locking Type
1817.406C-V	33W	24V DC	3000 (lm)	15°/30°/40°	30/90+	Push





SLIMDUET-P Seamless Installation

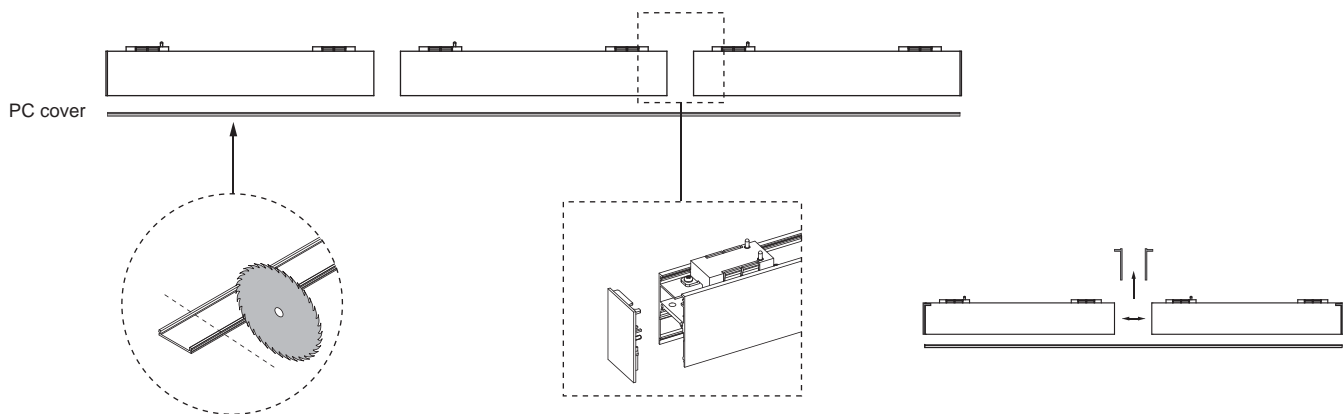

PC cover can be cut into required length

Remove the end cap from SLIMDUET-P module, the modules can be installed next to each other, then use longer PC cover to make seamless appearance.

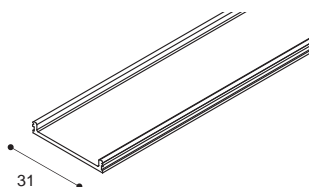

Colours White

Product performance _____

Article number L _____

SDE-01 4000mm

SDE-02 15000mm

SLIMDUET-P

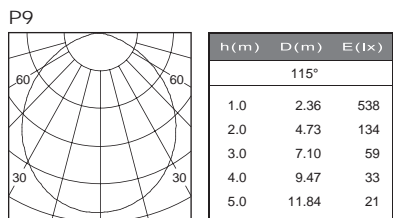
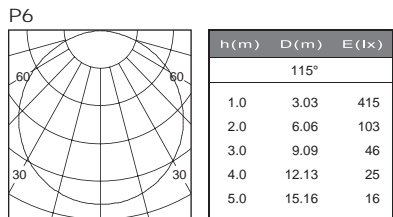
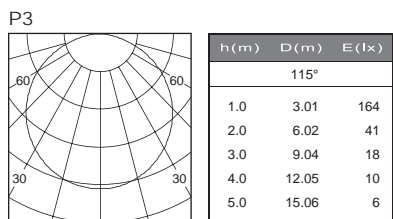
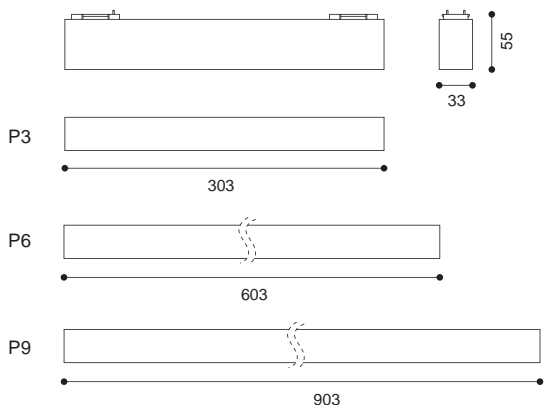

Colours Black White

Product performance

SLIMDUET-P3

Article number	LED Consumption	Voltage	System Lumen	Beam Angle	CCT/CRI	Locking Type
1817.410A-V	9.2W	24V DC	472 (lm)	115°	30/80+	Twist

SLIMDUET-P6

Article number	LED Consumption	Voltage	System Lumen	Beam Angle	CCT/CRI	Locking Type
1817.410B-V	18.4W	24V DC	1197 (lm)	115°	30/80+	Twist

SLIMDUET-P9

Article number	LED Consumption	Voltage	System Lumen	Beam Angle	CCT/CRI	Locking Type
1817.410C-V	27.5W	24V DC	1428 (lm)	115°	30/80+	Twist





SLIMDUET-W

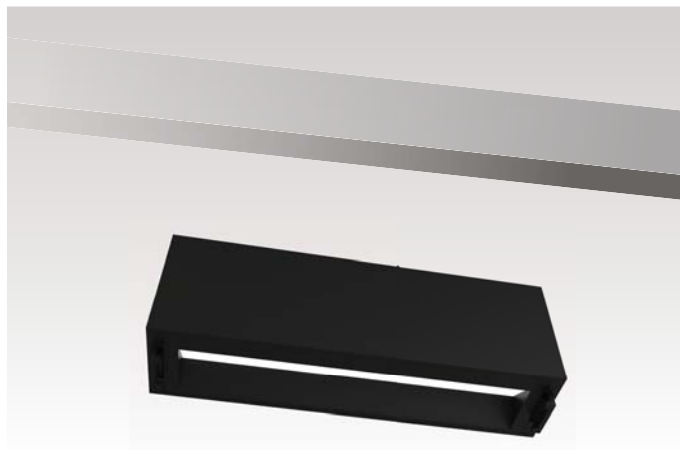
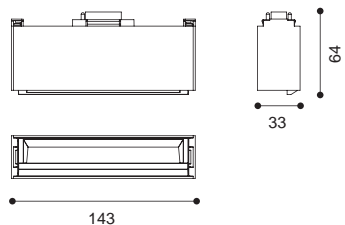

1817.407A-V

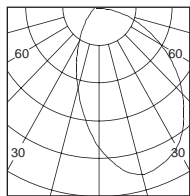

h(m)	D(m)	E(lx)
78°		
1.0	1.35	251
2.0	2.71	62
3.0	4.07	27
4.0	5.43	15
5.0	6.79	10

- Colours Black White
- Baffle : Black

Product performance

Article number	LED Consumption	Voltage	System Lumen	Beam Angle	CCT/CRI	Locking Type
1817.407A-V	11W	24V DC	462 (lm)	wallwash	30/90+	Push





SLIMDUET-S

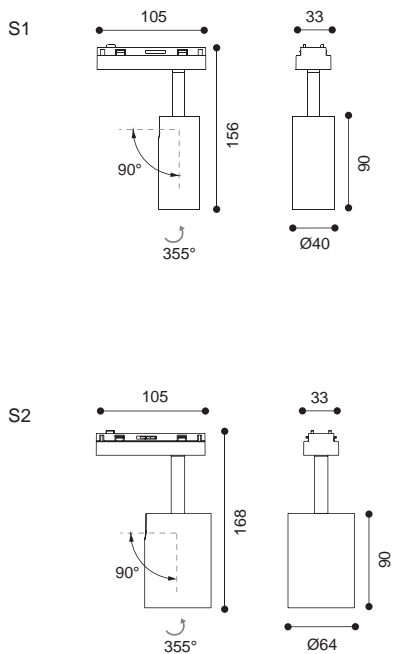

1617.407-V

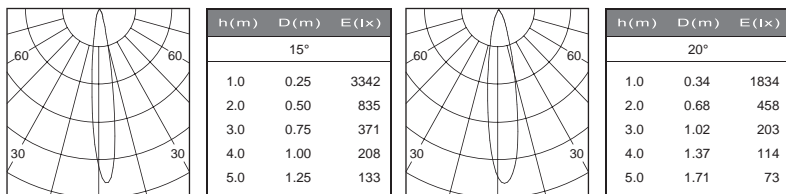

1617.411-V

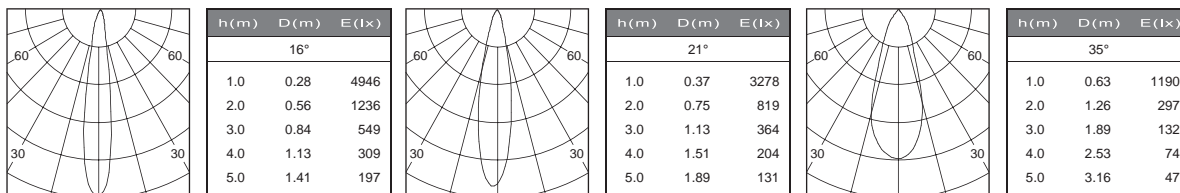

- Colours
 Black White
- Baffle :
 Black White Copper

Product performance

SLIMDUET-S1

Article number	LED Consumption	Voltage	Lumen	Beam Angle	CCT/CRI	Locking Type
1617.407-V	6.4W	24V DC	626 (lm)	15°/20°	30/90+	Twist

SLIMDUET-S2

Article number	LED Consumption	Voltage	Lumen	Beam Angle	CCT/CRI	Locking Type
1617.411-V	12.7W	24V DC	1114 (lm)	16°/21°/35°	30/90+	Twist





SLIMDUET-GR

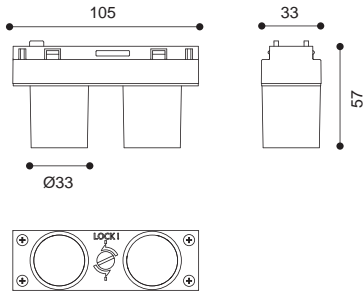

1817.401-V

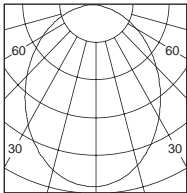

h(m)	D(m)	E(lx)
90°		
1.0	2	96
2.0	4	24
3.0	6	10
4.0	8	6
5.0	10	3

Colours Black White

Product performance

Article number	LED Consumption	Voltage	System Lumen	Beam Angle	CCT/CRI	Locking Type
1817.401-V	5.3W	24V DC	214 (lm)	90°	30/90+	Twist





SLIMDUET-GL

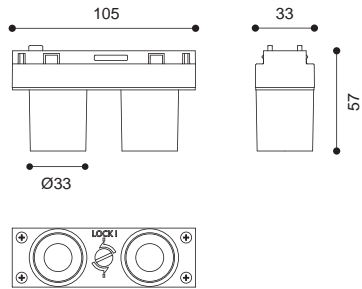

1617.409A

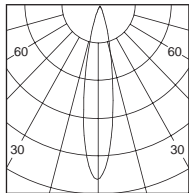

h(m)	D(m)	E(lx)
19°		
1.0	0.34	2290
2.0	0.68	572
3.0	1.02	254
4.0	1.36	143
5.0	1.70	91

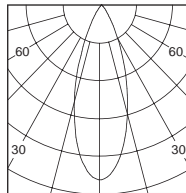

h(m)	D(m)	E(lx)
35°		
1.0	0.62	753
2.0	1.25	188
3.0	1.88	83
4.0	2.51	47
5.0	3.14	30

- Colours
 Black White
- Baffle :
 Black White Piano black

Product performance

Article number	LED Consumption	Voltage	Lumen	Beam Angle	CCT/CRI	Locking Type
1617.409A-V	5.3W	24V DC	399 (lm)	19°/35°	30/90+	Twist





SLIMDUET-C

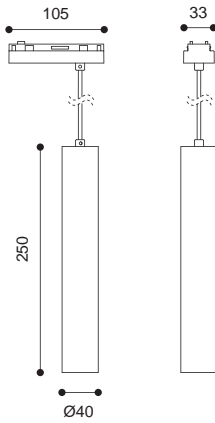

1617.410

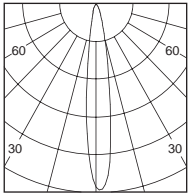

h(m)	D(m)	E(lx)
10°		
1.0	0.25	3417
2.0	0.51	854
3.0	0.76	379
4.0	1.02	213
5.0	1.27	136

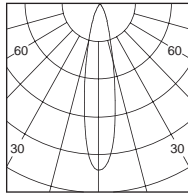

h(m)	D(m)	E(lx)
20°		
1.0	0.37	1755
2.0	0.74	438
3.0	1.12	194
4.0	1.49	109
5.0	1.86	70

- Colours
 Black White
- Baffle :
 Black White Copper

Product performance

Article number	LED Consumption	Voltage	Lumen	Beam Angle	CCT/CRI	Locking Type
1617.410-V	6.4W	24V DC	626 (lm)	10°/ 20°	30/90+	Twist





SLIMDUET-KC

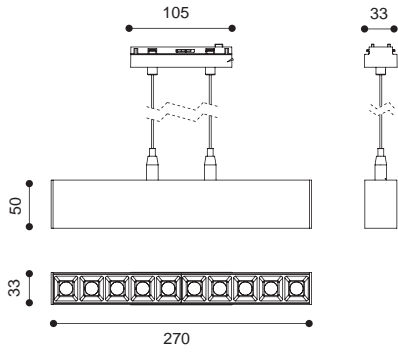

1817.411-V

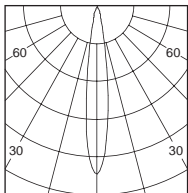

h(m)	D(m)	E(lx)
15°		
1.0	0.26	12704
2.0	0.52	3176
3.0	0.78	1412
4.0	1.05	794
5.0	1.31	508

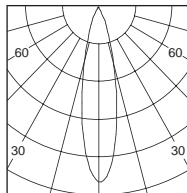

h(m)	D(m)	E(lx)
25°		
1.0	0.40	6526
2.0	0.81	1632
3.0	1.22	725
4.0	1.62	407
5.0	2.03	261

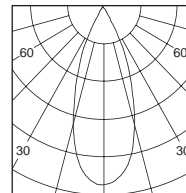

h(m)	D(m)	E(lx)
40°		
1.0	0.68	3318
2.0	1.36	829
3.0	2.04	368
4.0	2.72	207
5.0	3.40	132

- Colours Black White
- Baffle : Black White Piano black

Product performance

Article number	LED Consumption	Voltage	Lumen	Beam Angle	CCT/CRI	Locking Type
1817.411-V	22W	24V DC	2000 (lm)	15°/25°/40°	30/90+	Twist





SLIMDUET-KS

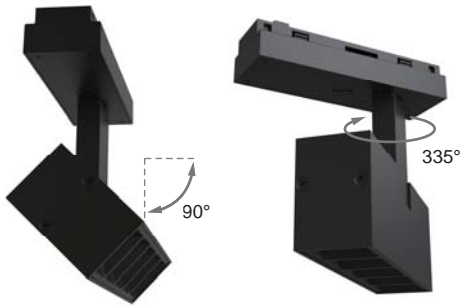
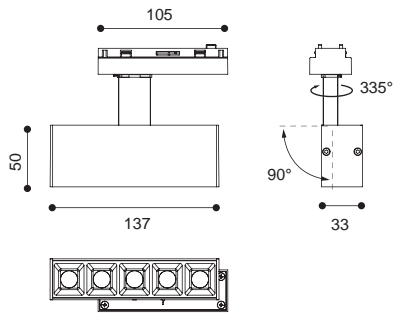

1817.413

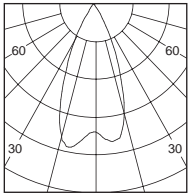

h(m)	D(m)	E(lx)
44°		
1.0	0.80	1543
2.0	1.60	385
3.0	2.40	171
4.0	3.20	96
5.0	4.00	61

- Colours Black White
- Baffle : Black White Piano black

Product performance

Article number	LED Consumption	Voltage	Lumen	Beam Angle	CCT/CRI	Locking Type
1817.413-V	11W	24V DC	1000 (lm)	15°/30°/40°	30/90+	Twist

