

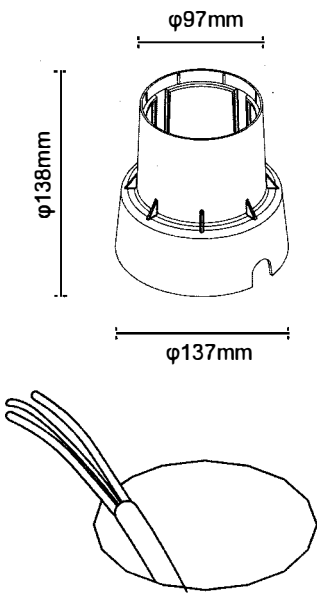

1

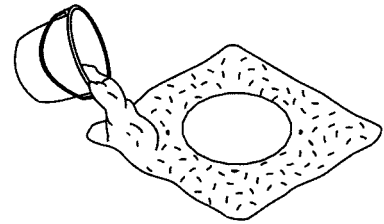

2

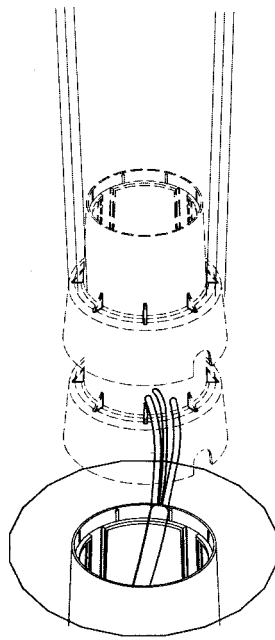

FLUSH WITH THE
INSTALLATION SURFACE

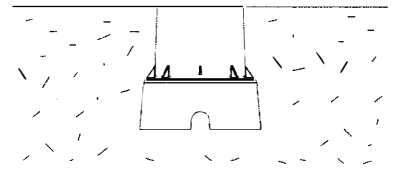

3



ASYMMETRICAL VERSION ONLY
MAKE SURE THE RECESSED SLEEVE
FACES THE RIGHT DIRECTION.

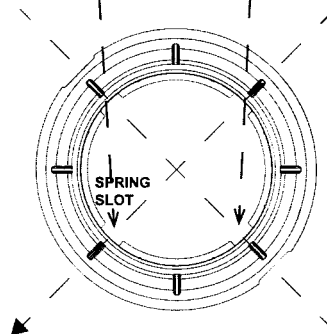
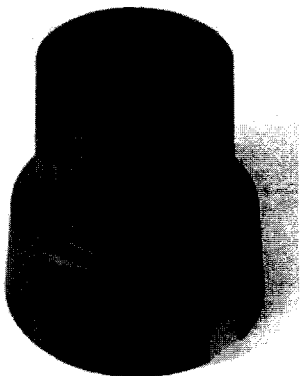
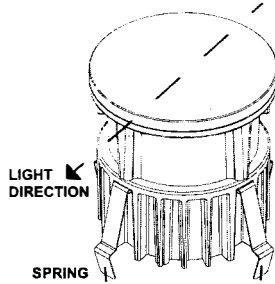
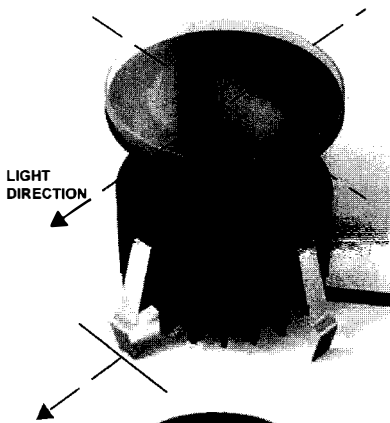

4



IP 68 CONNECTION

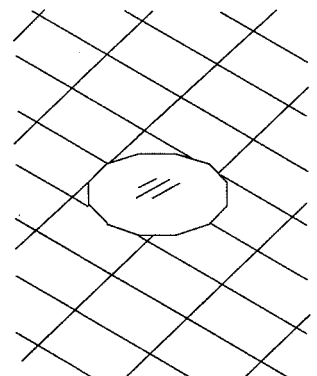
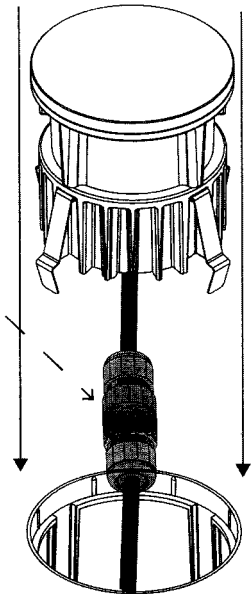



QUALIFIED TECHNICIAN



Connection and maintenance of the luminaire must be carried out by trained and qualified technician only, in compliance with the regulation in force.

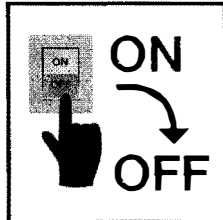

Make sure there is no power connected to the fitting before carrying out any maintenance.

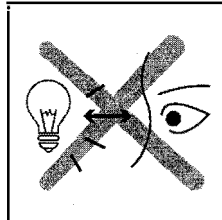

LED risk group 0-1 IEC 62471
Do not stare at operating luminaire. May be harmful to the eyes.

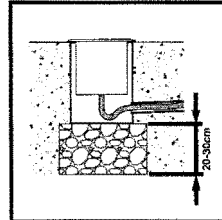

Place the inground luminaire on a 20-30cm drainage layer (gravel) and fill it with water, if after 30 minutes water is still in the luminaire it is compulsory to integrate an additional draining system (e.g. drain pipe).

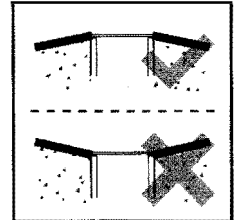

To avoid water stagnation, do not place the inground luminaire for installation on hollow areas.

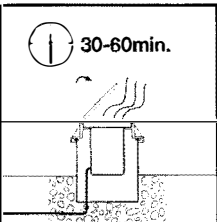

If you disassemble the inground luminaires, projectors or bollards. Make the luminaires working for 30-60 minutes before to assemble them. In order to avoid the moisture.

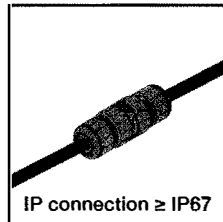

The protection rating of the electrical connection for the luminaires with factory pre-wired connection cable must be equal to or greater than the IP67.

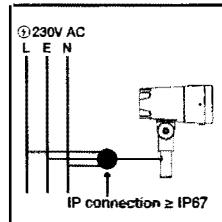

The protection rating of the electrical connection for projectors must be equal to or greater than the IP67.

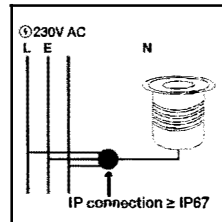

The protection rating of the electrical connection for inground luminaires must be equal to or greater than the IP67.



All luminaires are equipped with a H2O STOP system giving effective protection against water or moisture passage along connecting cables.

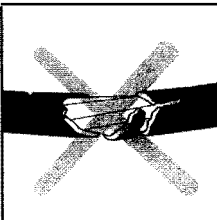

If the external flexible cable or cord of the luminaire is damaged, it shall be exclusively replaced by the manufacturer or qualified technician, in order to avoid a hazard.

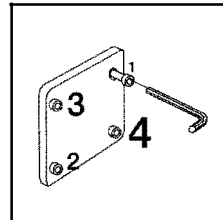

Tighten and release screws alternately or cross wise.

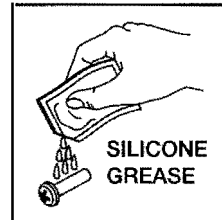

For an easy maintenance (unscrewing) of the luminaire we recommend protecting screws threads with silicone grease before exposure to weather.



Keep the luminaire clean to prevent dirt deposit on frames and screws' head. On stainless steel parts use dedicated cleaners only.

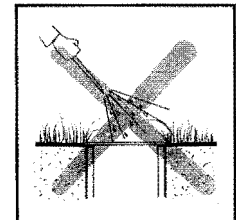

Keep away from aggressive agents and chemical substances (e.g. fertilize, weed-killer, lime).

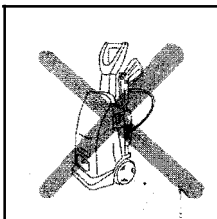

Do not use water high pressure cleaners.

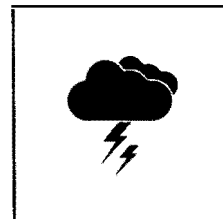

Electronic equipment sensitive to voltage surges. The installation of a protection device against overvoltages on the electrical system attenuates the intensity of these phenomena protecting apparatus from the risk of damage.

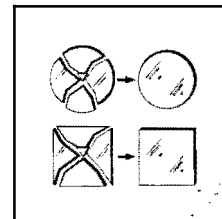

In case of diffuser damage change it before to switch on the fitting.

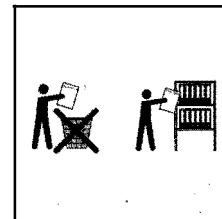

Retain the instructions.

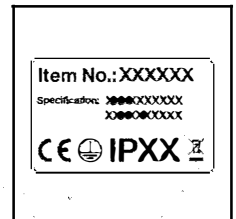

Technical data on the product rating label.