

PRODUCT FEATURES

- Line Voltage 220–240V – No Driver Required
- Easy and Quick Snap Connection
- Innovative Slim Design
- Seamless and Spot Free
- Line Voltage Phase Dimming
- Compatible with 3rd party dimmers
- Flicker Free
- Various accessories option

PRODUCT SPECIFICATIONS

- Voltage : AC 220–240V
- Operating Temperature : 0–45°C (32–113°F)
- Lamp Life : 50,000hr / 70%
- Available Color : 2700K, 3000K, 3500K, 4000K
- Color Rendering : CRI>90
- Beam Angle:130°
- 3 year warranty

MAX. CONNECTION

- 400W in one row (single power feed)

DIMENSIONS

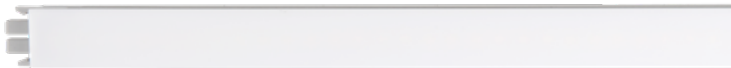

NDF3 / FLX Stix NDFree 3W length 156mm(6.1")

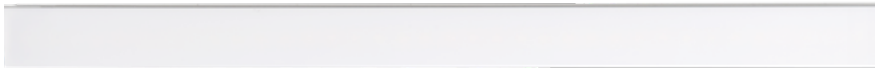

NDF5 / FLX Stix NDFree 5W length 291.5mm(11.5")

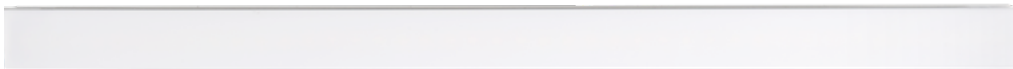

NDF10 / FLX Stix NDFree 10W length 569.5mm(22.4")

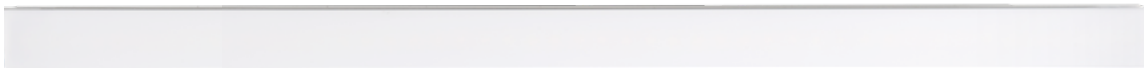

NDF15 / FLX Stix NDFree 15W length 848mm(33.4")

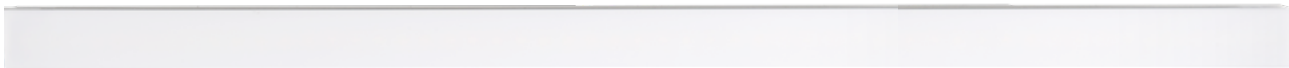

NDF20 / FLX Stix NDFree 20W length 1,126mm(44.3")



| Model Number | Voltage Input (V) | Lamp Power (W) | Lumens(lm) (CRI90) | A mm (inches) | B mm (inches) | C mm (inches) | D mm (inches) | E mm (inches) | F mm (inches) | G mm (inches) |
|----------------------------|-------------------|----------------|--------------------|---------------|---------------|----------------|---------------|---------------|---------------|---------------|
| NDF3-(Color)K-230V-C90-FF | AC 220–240V | 2.5 | 212 | 147 (5.8) | 156 (6.1) | 178.7 (7) | 19 (0.75) | 18 (0.71) | 18 (0.71) | 16.8 (0.66) |
| NDF5-(Color)K-230V-C90-FF | AC 220–240V | 5.34 | 340 | 282.5 (11.1) | 291.5 (11.5) | 314 (12.4) | 19 (0.75) | 18 (0.71) | 18 (0.71) | 16.8 (0.66) |
| NDF10-(Color)K-230V-C90-FF | AC 220–240V | 10.93 | 720 | 560.5 (22) | 569.5 (22.4) | 592 (23.3) | 19 (0.75) | 18 (0.71) | 18 (0.71) | 16.8 (0.66) |
| NDF15-(Color)K-230V-C90-FF | AC 220–240V | 16.08 | 1,080 | 839 (33) | 848 (33.4) | 870.5 (34.3) | 19 (0.75) | 18 (0.71) | 18 (0.71) | 16.8 (0.66) |
| NDF20-(Color)K-230V-C90-FF | AC 220–240V | 21.3 | 1,440 | 1,117 (43.4) | 1,126 (44.3) | 1,148.5 (45.2) | 19 (0.75) | 18 (0.71) | 18 (0.71) | 16.8 (0.66) |

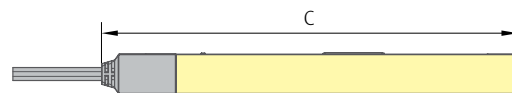
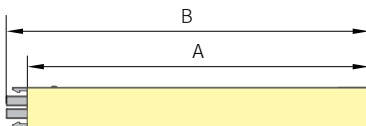

w/bracket

* LED 90° Connector
NDF3 40K-230V-C90-FF-90

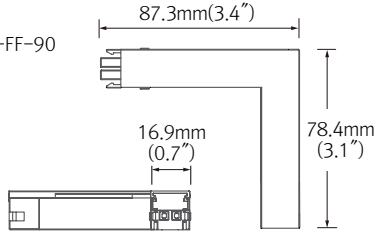

* NDF ON/OFF Switch

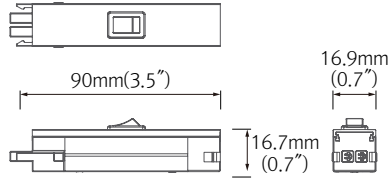

* LED Power Cord
NDF3 40K-230V-C90-FF-PC / OPC

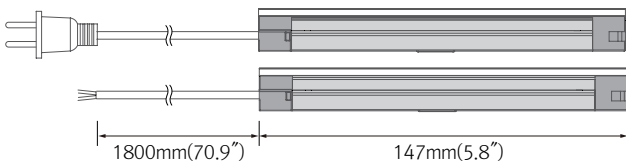

* Flexible Connector

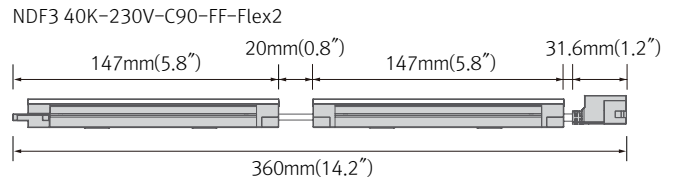

NDF3 40K-230V-C90-FF-Flex3

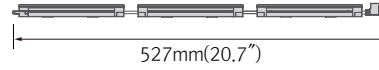

NDF3 40K-230V-C90-FF-Flex5

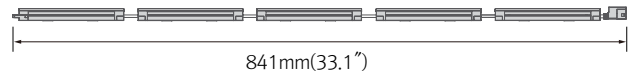

* NDF PENDANT

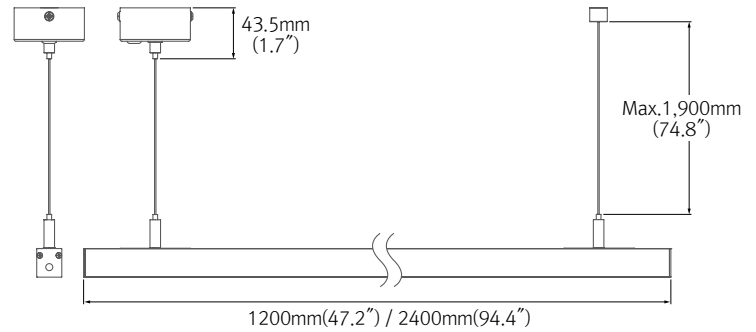

* NDF Extrusion Line

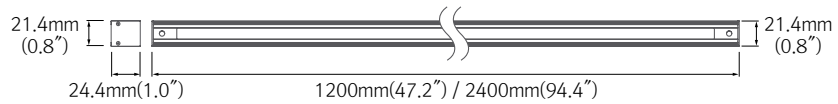

BEAM SPREADS

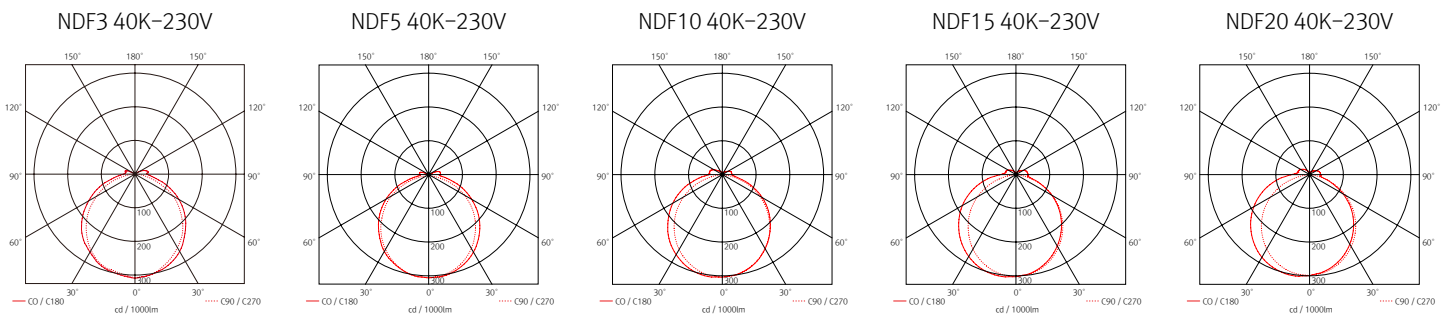

EASY CONNECTION

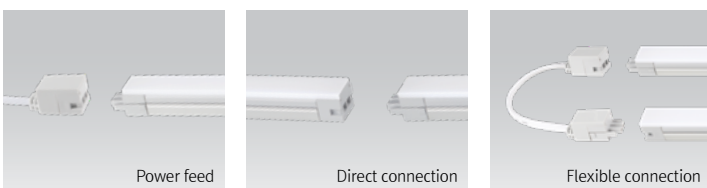

VARIOUS OPTIONS



INSTALLATION

☆Before Installation(Power Connection)

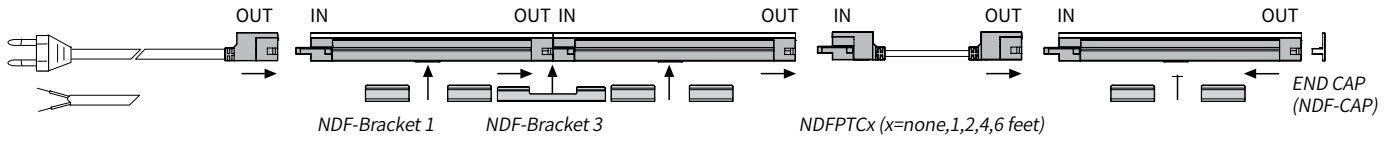

☆After Installation

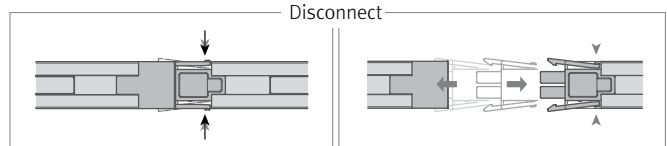
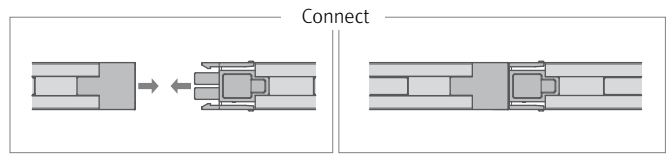
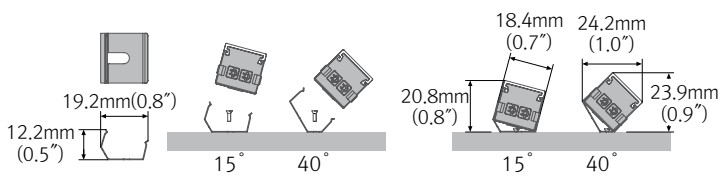
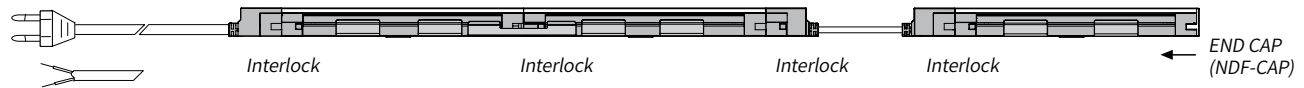

* When you disconnect NDF, please push the connector button and pull-out fixtures.

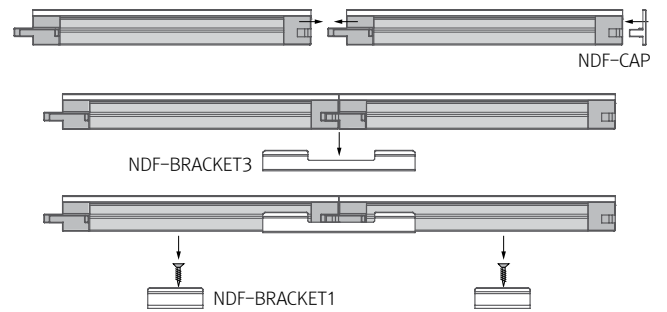
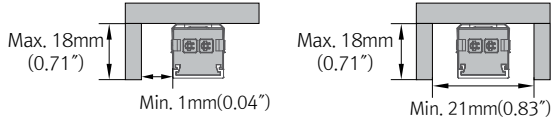

☆Pendant Installation

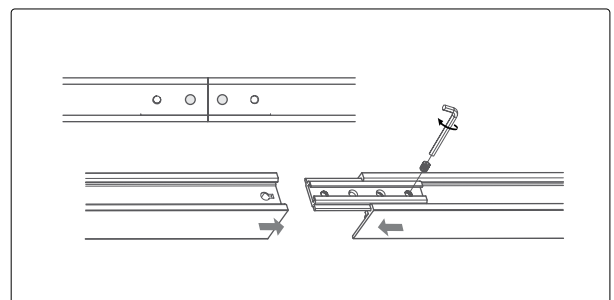
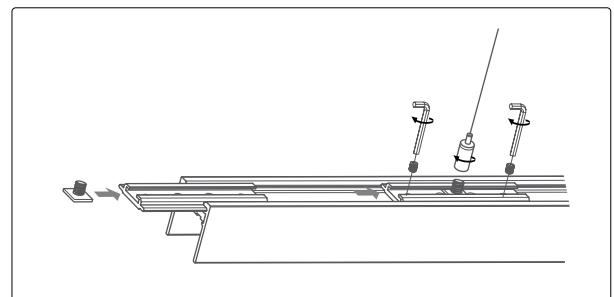
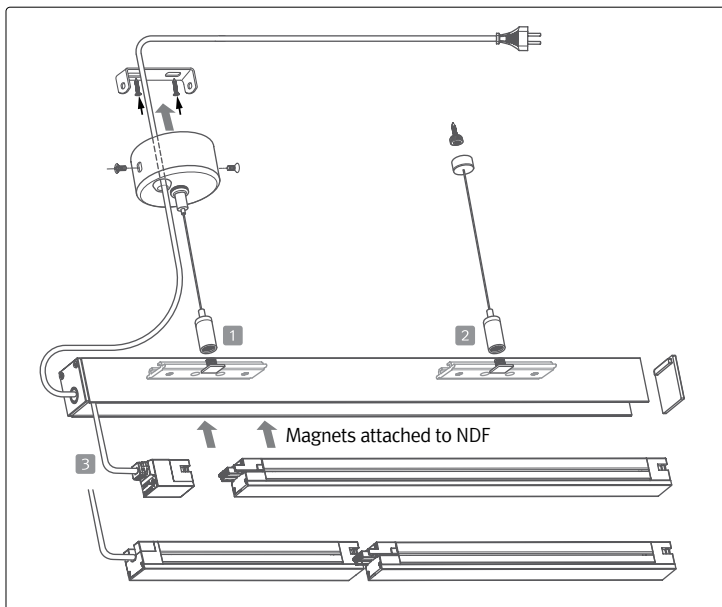

COMPONENTS



LED Power connector
 __NDF3-(Color)K-230V-PC
 NDF3 (150mm) fixture with
 1,800mm power cord



Power Cord
 __NDFPC/T (1,800mm)



Mounting Bracket
 __NDF-BRACKET1
 Included with fixture

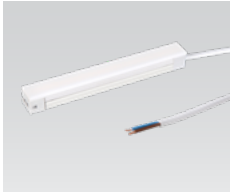

LED open power connector
 __NDF3-(Color)K-230V-OPC
 NDF3 (150mm) fixture with
 1,800mm open power cord

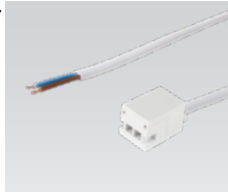

Open Power Cord
 __NDFOPC/T (1,800mm)



Angle bracket
 __NDF-BRACKET2



LED 90° Connector
 __NDF3-(Color)K-230V-90

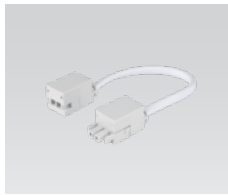

Connecting Cable
 __NDFPTC/T (150mm)
 __NDFPTC1/T (300mm)
 __NDFPTC2/T (600mm)
 __NDFPTC4/T (1,200mm)
 __NDFPTC6/T (1,800mm)



Connecting bracket
 __NDF-BRACKET3
 Included with fixture



Flexible Connector
 __NDF3-(Color)K-230V-Flex2
 (359.5mm)
 __NDF3-(Color)K-230V-Flex3
 (521.5mm)
 __NDF3-(Color)K-230V-Flex5
 (830.5mm)



End Cap
 __NDF-CAP
 Included with fixture



Suspension bracket
 __NDF-SK-BRACKET
 Suspension Bracket for NDF



On/Off Switch
 __NDF-SW



NDF Extrusion line
 __NDF-EXL (1.2m)
 __NDF-EXL (2.4m)

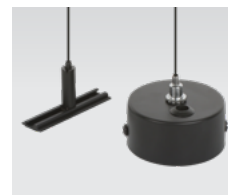

Suspension Power Kit
 __NDF-SK-POWER
 Suspension Power Kit
 for NDF



**Dimming Interface
 (Bluetooth)**
 __FDS-H1B-SR
 Max. 200W (100W/CH,1CH)



**Dimming Interface
 (Dail)**
 __FDS-H1DA-SR
 Max. 200W (200W/CH,1CH)



**Dimming Interface
 (Dail)**
 __FDS-H2DA-SR
 Max. 288W (144W/CH,2CH)